



Control Quick Start Guide

Unidrive M400

**Manufacturing Automation drive
Fast set-up and diagnosis with
real-text display, plus integrated
Machine Control Studio based PLC**

Part Number: 0478-0267-04
Issue: 4

Original Instructions

For the purposes of compliance with the EU Machinery Directive 2006/42/EC, the English version of this manual is the Original Instructions. Manuals in other languages are Translations of the Original Instructions.

Documentation

Manuals are available to download from the following locations: <http://www.drive-setup.com/ctdownloads>

The information contained in this manual is believed to be correct at the time of printing and does not form part of any contract. The manufacturer reserves the right to change the specification of the product and its performance, and the contents of the manual, without notice.

Warranty and Liability

In no event and under no circumstances shall the manufacturer be liable for damages and failures due to misuse, abuse, improper installation, or abnormal conditions of temperature, dust, or corrosion, or failures due to operation outside the published ratings. The manufacturer is not liable for consequential and incidental damages. Contact the supplier of the drive for full details of the warranty terms.

Environmental policy

Control Techniques Ltd operates an Environmental Management System (EMS) that conforms to the International Standard ISO 14001.

Further information on our Environmental Policy can be found at: <http://www.drive-setup.com/environment>

Restriction of Hazardous Substances (RoHS)

The products covered by this manual comply with European and International regulations on the Restriction of Hazardous Substances including EU directive 2011/65/EU and the Chinese Administrative Measures for Restriction of Hazardous Substances in Electrical and Electronic Products.

Disposal and Recycling (WEEE)



When electronic products reach the end of their useful life, they must not be disposed of along with domestic waste but should be recycled by a specialist recycler of electronic equipment. Control Techniques products are designed to be easily dismantled into their major component parts for efficient recycling. The majority of materials used in the product are suitable for recycling.

Product packaging is of good quality and can be re-used. Large products are packed in wooden crates. Smaller products are packaged in strong cardboard cartons which have a high recycled fibre content. Cartons can be re-used and recycled. Polythene, used in protective film and bags for wrapping the product, can be recycled. When preparing to recycle or dispose of any product or packaging, please observe local legislation and best practice.

REACH legislation

EC Regulation 1907/2006 on the Registration, Evaluation, Authorisation and restriction of Chemicals (REACH) requires the supplier of an article to inform the recipient if it contains more than a specified proportion of any substance which is considered by the European Chemicals Agency (ECHA) to be a Substance of Very High Concern (SVHC) and is therefore listed by them as a candidate for compulsory authorisation.

Further information on our compliance with REACH can be found at: <http://www.drive-setup.com/reach>

Registered Office

Nidec Control Techniques Ltd
The Gro
Newtown
Powys
SY16 3BE
UK

Registered in England and Wales. Company Reg. No. 01236886.

Copyright

The contents of this publication are believed to be correct at the time of printing. In the interests of a commitment to a policy of continuous development and improvement, the manufacturer reserves the right to change the specification of the product or its performance, or the contents of the guide, without notice.

All rights reserved. No parts of this guide may be reproduced or transmitted in any form or by any means, electrical or mechanical including photocopying, recording or by an information storage or retrieval system, without permission in writing from the publisher.

Copyright © February 2018 Nidec Control Techniques Ltd

Contents

1	Safety information	5
1.1	Warnings, Cautions and Notes	5
1.2	Important safety information. Hazards. Competence of designers and installers	5
1.3	Responsibility	5
1.4	Compliance with regulations	5
1.5	Electrical hazards	6
1.6	Stored electrical charge	6
1.7	Mechanical hazards	6
1.8	Access to equipment	6
1.9	Environmental limits	6
1.10	Hazardous environments	7
1.11	Motor	7
1.12	Mechanical brake control	7
1.13	Adjusting parameters	7
1.14	Electromagnetic compatibility (EMC)	7
2	Introduction	8
2.1	Operating modes	8
3	Options	9
4	Control connections	10
4.1	Control terminal configurations and wiring	10
4.2	Safe Torque Off (STO)	16
5	Optional LCD keypad and display	17
5.1	Saving parameters	18
5.2	Restoring parameter defaults	18
6	Basic parameters (Menu 0)	19
6.1	Menu 0: Basic parameters	19
6.2	Unidrive M400 parameter descriptions	26
7	Running the motor	50
8	Diagnostics	52
8.1	Alarm indications	56
9	NV Media Card Operation	57
10	Machine Control Studio	58
11	Default control connections	59

1 Safety information

1.1 Warnings, Cautions and Notes



A Warning contains information which is essential for avoiding a safety hazard.



A Caution contains information which is necessary for avoiding a risk of damage to the product or other equipment.

NOTE

A Note contains information, which helps to ensure correct operation of the product.

1.2 Important safety information. Hazards. Competence of designers and installers

This guide applies to products which control electric motors either directly (drives) or indirectly (controllers, option modules and other auxiliary equipment and accessories). In all cases the hazards associated with powerful electrical drives are present, and all safety information relating to drives and associated equipment must be observed.

Specific warnings are given at the relevant places in this guide.

Drives and controllers are intended as components for professional incorporation into complete systems. If installed incorrectly they may present a safety hazard. The drive uses high voltages and currents, carries a high level of stored electrical energy, and is used to control equipment which can cause injury. Close attention is required to the electrical installation and the system design to avoid hazards either in normal operation or in the event of equipment malfunction. System design, installation, commissioning/start-up and maintenance must be carried out by personnel who have the necessary training and competence. They must read this safety information and this guide carefully.

1.3 Responsibility

It is the responsibility of the installer to ensure that the equipment is installed correctly with regard to all instructions given in this guide. They must give due consideration to the safety of the complete system, so as to avoid the risk of injury both in normal operation and in the event of a fault or of reasonably foreseeable misuse.

The manufacturer accepts no liability for any consequences resulting from inappropriate, negligent or incorrect installation of the equipment.

1.4 Compliance with regulations

The installer is responsible for complying with all relevant regulations, such as national wiring regulations, accident prevention regulations and electromagnetic compatibility (EMC) regulations. Particular attention must be given to the cross-sectional areas of conductors, the selection of fuses or other protection, and protective ground (earth) connections.

This guide contains instructions for achieving compliance with specific EMC standards.

All machinery to be supplied within the European Union in which this product is used must comply with the following directives:

2006/42/EC Safety of machinery.

2014/30/EU: Electromagnetic Compatibility.

1.5 Electrical hazards

The voltages used in the drive can cause severe electrical shock and/or burns, and could be lethal. Extreme care is necessary at all times when working with or adjacent to the drive. Hazardous voltage may be present in any of the following locations:

- AC and DC supply cables and connections
- Output cables and connections
- Many internal parts of the drive, and external option units

Unless otherwise indicated, control terminals are single insulated and must not be touched.

The supply must be disconnected by an approved electrical isolation device before gaining access to the electrical connections.

The STOP and Safe Torque Off functions of the drive do not isolate dangerous voltages from the output of the drive or from any external option unit.

The drive must be installed in accordance with the instructions given in this guide. Failure to observe the instructions could result in a fire hazard.

1.6 Stored electrical charge

The drive contains capacitors that remain charged to a potentially lethal voltage after the AC supply has been disconnected. If the drive has been energized, the AC supply must be isolated at least ten minutes before work may continue.

1.7 Mechanical hazards

Careful consideration must be given to the functions of the drive or controller which might result in a hazard, either through their intended behaviour or through incorrect operation due to a fault. In any application where a malfunction of the drive or its control system could lead to or allow damage, loss or injury, a risk analysis must be carried out, and where necessary, further measures taken to reduce the risk - for example, an over-speed protection device in case of failure of the speed control, or a fail-safe mechanical brake in case of loss of motor braking.

With the sole exception of the Safe Torque Off function, none of the drive functions must be used to ensure safety of personnel, i.e. they must not be used for safety-related functions.

The Safe Torque Off function may be used in a safety-related application. The system designer is responsible for ensuring that the complete system is safe and designed correctly according to the relevant safety standards.

The design of safety-related control systems must only be done by personnel with the required training and experience. The Safe Torque Off function will only ensure the safety of a machine if it is correctly incorporated into a complete safety system. The system must be subject to a risk assessment to confirm that the residual risk of an unsafe event is at an acceptable level for the application.

1.8 Access to equipment

Access must be restricted to authorized personnel only. Safety regulations which apply at the place of use must be complied with.

1.9 Environmental limits

Instructions in this guide regarding transport, storage, installation and use of the equipment must be complied with, including the specified environmental limits. This includes temperature, humidity, contamination, shock and vibration. Drives must not be subjected to excessive physical force.

1.10 Hazardous environments

The equipment must not be installed in a hazardous environment (i.e. a potentially explosive environment).

1.11 Motor

The safety of the motor under variable speed conditions must be ensured.

To avoid the risk of physical injury, do not exceed the maximum specified speed of the motor.

Low speeds may cause the motor to overheat because the cooling fan becomes less effective, causing a fire hazard. The motor should be installed with a protection thermistor. If necessary, an electric forced vent fan should be used.

The values of the motor parameters set in the drive affect the protection of the motor. The default values in the drive must not be relied upon. It is essential that the correct value is entered in the Motor Rated Current parameter.

1.12 Mechanical brake control

Any brake control functions are provided to allow well co-ordinated operation of an external brake with the drive. While both hardware and software are designed to high standards of quality and robustness, they are not intended for use as safety functions, i.e. where a fault or failure would result in a risk of injury. In any application where the incorrect operation of the brake release mechanism could result in injury, independent protection devices of proven integrity must also be incorporated.

1.13 Adjusting parameters

Some parameters have a profound effect on the operation of the drive. They must not be altered without careful consideration of the impact on the controlled system. Measures must be taken to prevent unwanted changes due to error or tampering.

1.14 Electromagnetic compatibility (EMC)

Installation instructions for a range of EMC environments are provided in the relevant Power Installation Guide. If the installation is poorly designed or other equipment does not comply with suitable standards for EMC, the product might cause or suffer from disturbance due to electromagnetic interaction with other equipment. It is the responsibility of the installer to ensure that the equipment or system into which the product is incorporated complies with the relevant EMC legislation in the place of use.

2 Introduction

M400 minimizes machine downtime with its optional intuitive advanced LCD Keypad that offers real-text multi-language display for rapid set-up and superior diagnostics. Its onboard PLC with real-time tasking can be used for simple logic control using Machine Control Studio programming software (powered by CODESYS) to enhance drive application capability.

2.1 Operating modes

The drive is designed to operate in any of the following modes:

1. Open loop mode
 - Open loop vector mode
 - Fixed V/F mode (V/Hz)
 - Square V/F mode (V/Hz)
2. RFC - A
 - Without position feedback sensor

2.1.1 Open loop mode

The drive applies power to the motor at frequencies varied by the user. The motor speed is a result of the output frequency of the drive and slip due to the mechanical load. The drive can improve the speed control of the motor by applying slip compensation. The performance at low speed depends on whether V/F mode or open loop vector mode is selected.

Open loop vector mode

The voltage applied to the motor is directly proportional to the frequency except at low speed where the drive uses motor parameters to apply the correct voltage to keep the flux constant under varying load conditions.

Typically 100 % torque is available down to 1 Hz for a 50 Hz motor.

Fixed V/F mode

The voltage applied to the motor is directly proportional to the frequency except at low speed where a voltage boost is provided which is set by the user. This mode can be used for multi-motor applications.

Typically 100 % torque is available down to 4 Hz for a 50 Hz motor.

Square V/F mode

The voltage applied to the motor is directly proportional to the square of the frequency except at low speed where a voltage boost is provided which is set by the user. This mode can be used for running fan or pump applications with quadratic load characteristics or for multi-motor applications. This mode is not suitable for applications requiring a high starting torque.

2.1.2 RFC-A mode

Rotor flux control provides closed loop control without the need for position feedback by using current, voltages and key motor parameters to estimate the motor speed. It can eliminate instability traditionally associated with open loop control such as operating large motors with light loads at low frequencies.

3 Options

Table 3-1 System Integration (SI) option module identification









Type	Option module	Color	Name	Further details
Fieldbus		Purple	SI-PROFIBUS	See relevant option module User Guide
		Medium Grey	SI-DeviceNet	
		Light Grey	SI-CANopen	
		Beige	SI-Ethernet	
		Brown Red	SI-EtherCAT	
		Yellow Green	SI-PROFINET V2	
Automation (I/O expansion)		Orange	SI-I/O	

Table 3-2 Adaptor Interface (AI) option module identification

Type	Option module	Name
Communications		AI-485 Adaptor
		AI-485 24 V Adaptor
Backup		AI-Backup Adaptor
Backup		AI-SMART Adaptor

4 Control connections

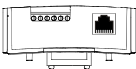
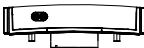
For information on the default control connections, refer to the back cover of this guide. The functionality of the control connections change depending on the setting of Pr **00.005**.

4.1 Control terminal configurations and wiring

00.005		Drive Configuration								
RW	Txt							PT	US	
OL	⇕	AV (0), AI (1), AV Preset (2), AI Preset (3), Preset (4), Keypad (5), Keypad Ref (6), Electronic Pot (7), Torque Control (8), Pid Control (9)					⇒	AV (0)		
RFC-A										

The setting of Pr **00.005** automatically sets the drive configuration.

Value	Text	Description
0	AV	Analog input 1 (voltage) or Analog input 2 (voltage) selected by terminal (Local/Remote)
1	AI	Analog input 1 (current) or Analog input 2 (voltage) selected by terminal (Local/Remote)
2	AV Preset	Analog input 1 (voltage) or 3 presets selected by terminal
3	AI Preset	Analog input 1 (current) or 3 presets selected by terminal
4	Preset	Four presets selected by terminal
5	Keypad	Keypad reference
6	Keypad Ref	Keypad reference with terminal control
7	Electronic Pot	Electronic Potentiometer
8	Torque Control	Torque mode, Analog input 1 (current frequency reference) or Analog input 2 (voltage torque reference) selected by terminal
9	Pid Control	PID mode, Analog input 1 (current feedback source) and Analog input 2 (voltage reference source)

Action will only occur if the drive is inactive, and no User Actions are running. Otherwise, the parameter will return to its pre altered value on exit from edit mode. All parameters are saved if this parameter changes.

Figure 4-1 Pr 00.005 = AV

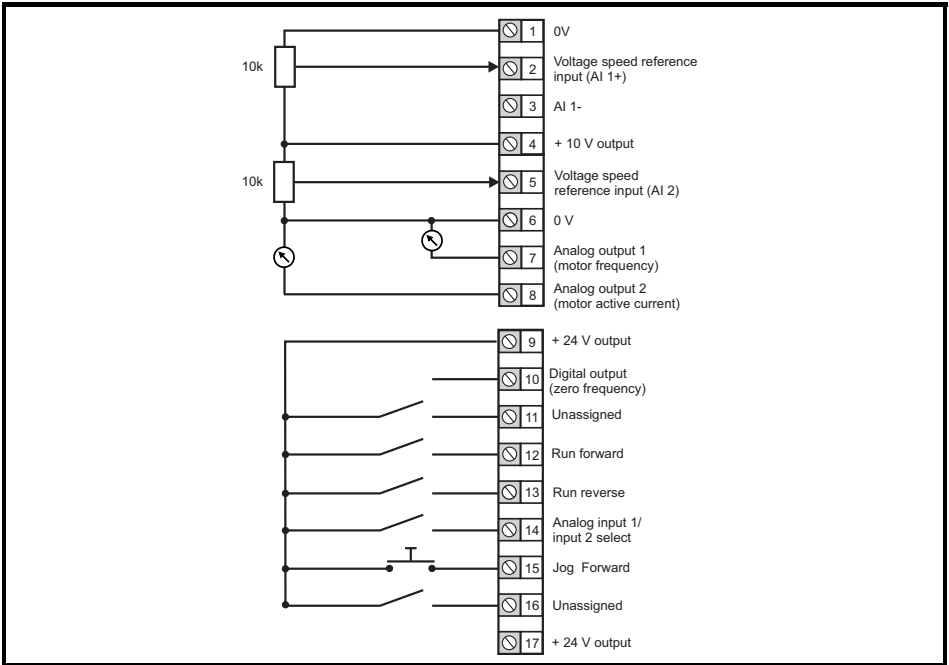

Figure 4-2 Pr 00.005 = AI

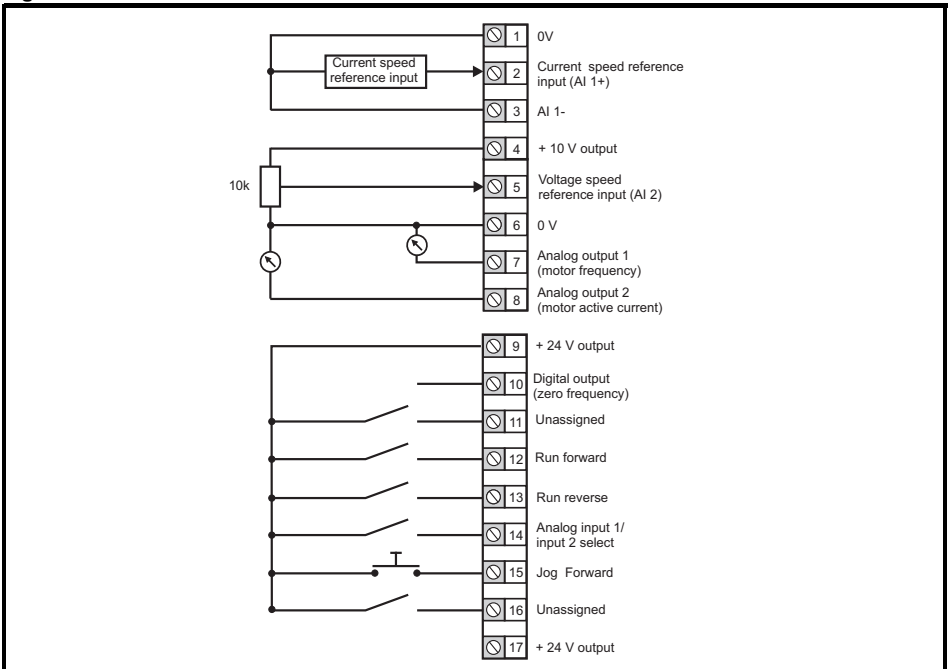

Figure 4-3 Pr 00.005 = AV Preset

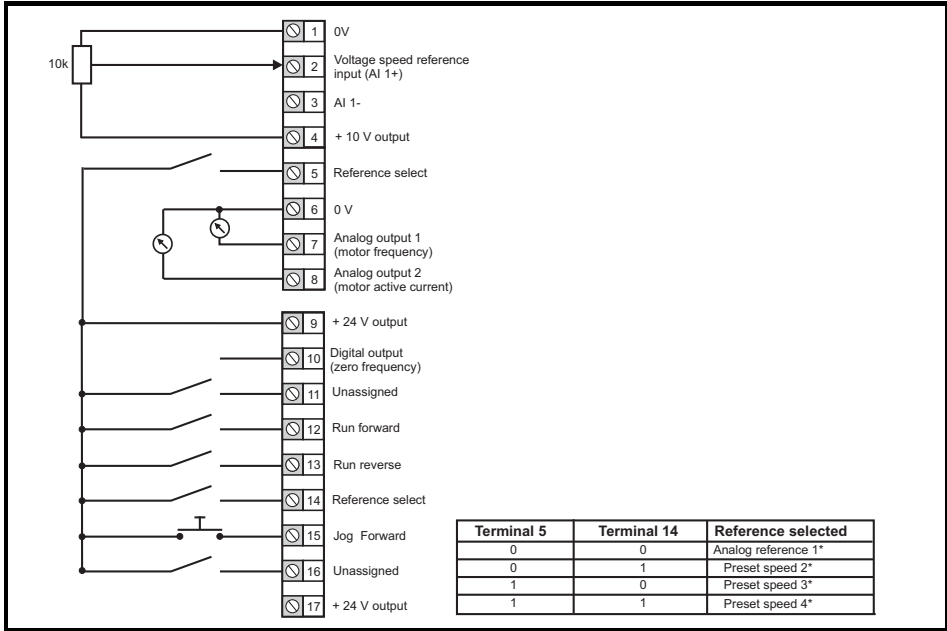
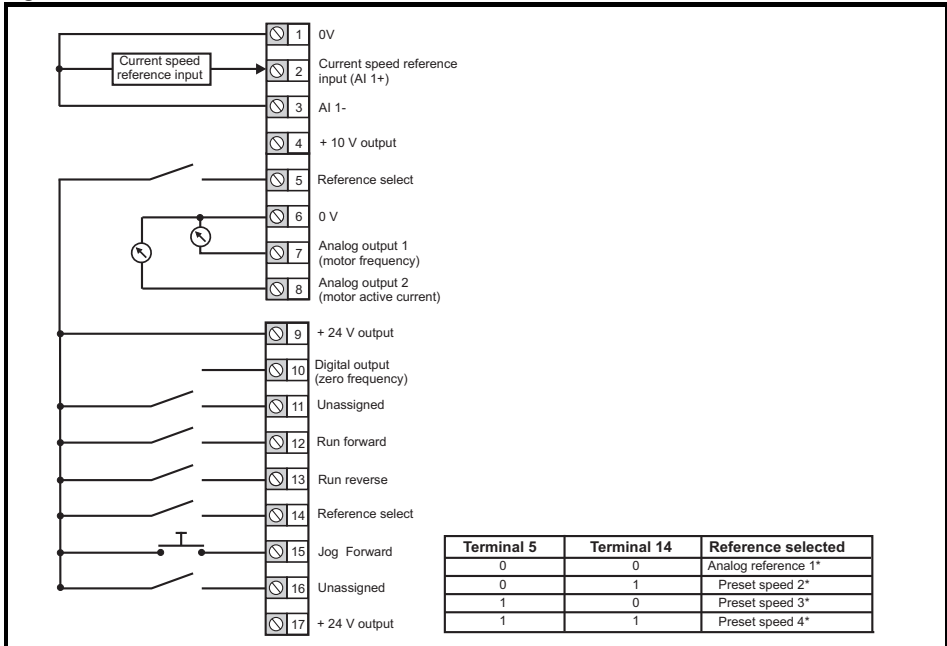
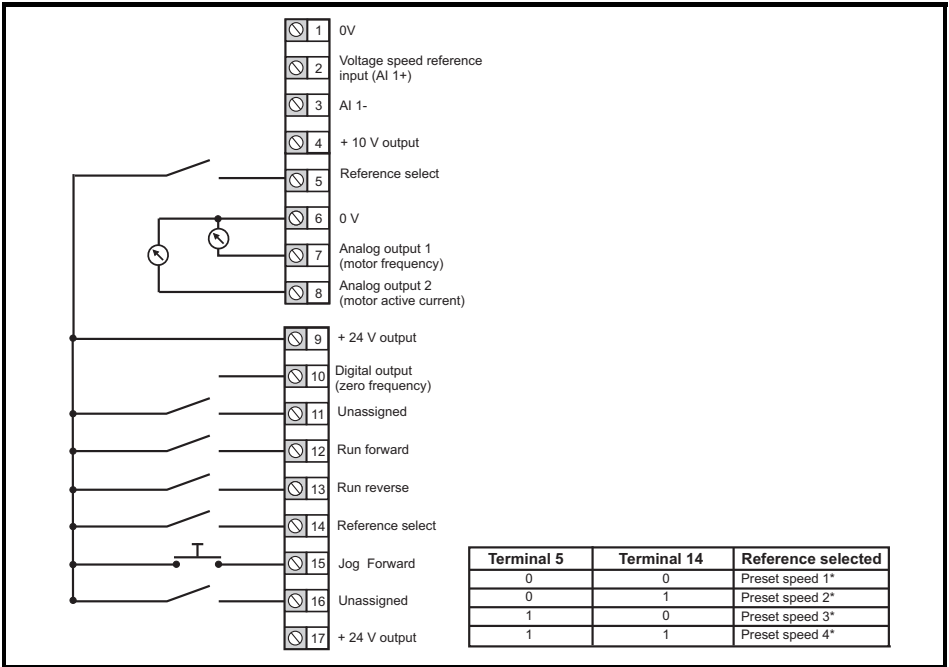

Figure 4-4 Pr 00.005 = AI Preset



* Refer to the *Control User Guide*.

Figure 4-5 Pr 00.005 = Preset



* Refer to the *Control User Guide*.

Figure 4-6 Pr 00.005 = Keypad

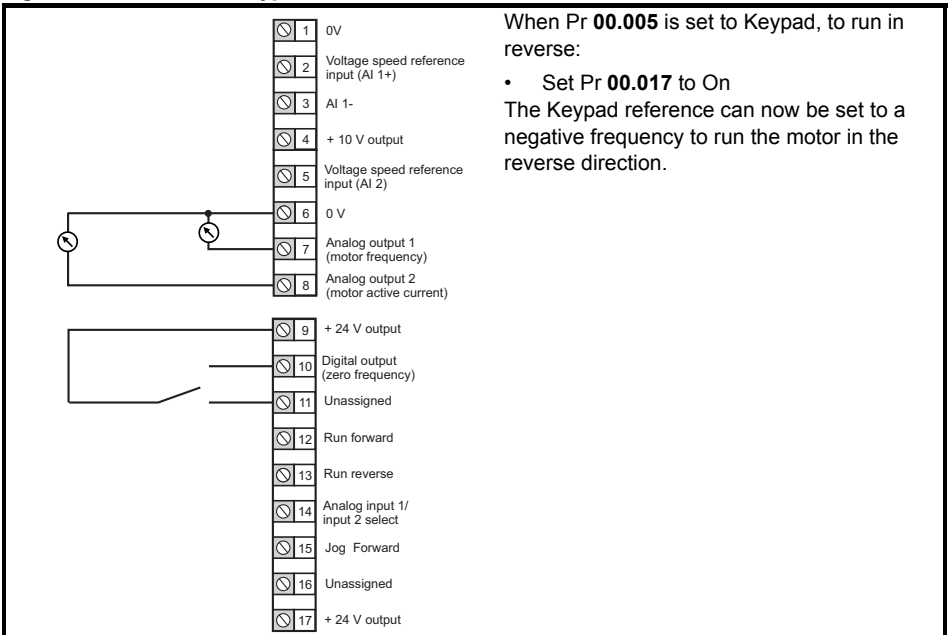

Figure 4-7 Pr 00.005 = Keypad Ref

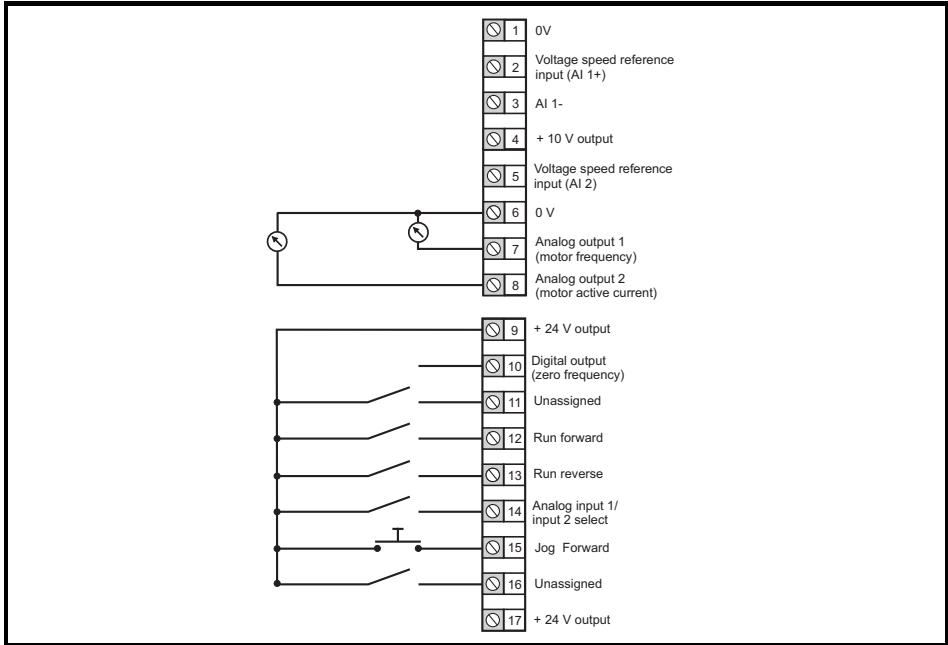
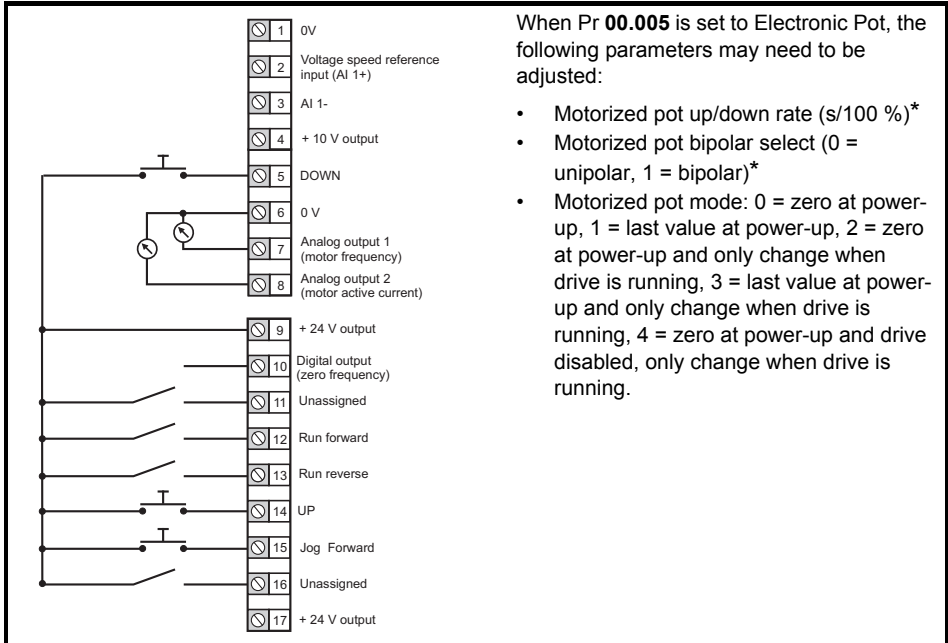

Figure 4-8 Pr 00.005 = Electronic Pot



When Pr **00.005** is set to Electronic Pot, the following parameters may need to be adjusted:

- Motorized pot up/down rate (s/100 %)*
- Motorized pot bipolar select (0 = unipolar, 1 = bipolar)*
- Motorized pot mode: 0 = zero at power-up, 1 = last value at power-up, 2 = zero at power-up and only change when drive is running, 3 = last value at power-up and only change when drive is running, 4 = zero at power-up and drive disabled, only change when drive is running.

* Refer to the *Control User Guide*.

Figure 4-9 Pr 00.005 = Torque Control

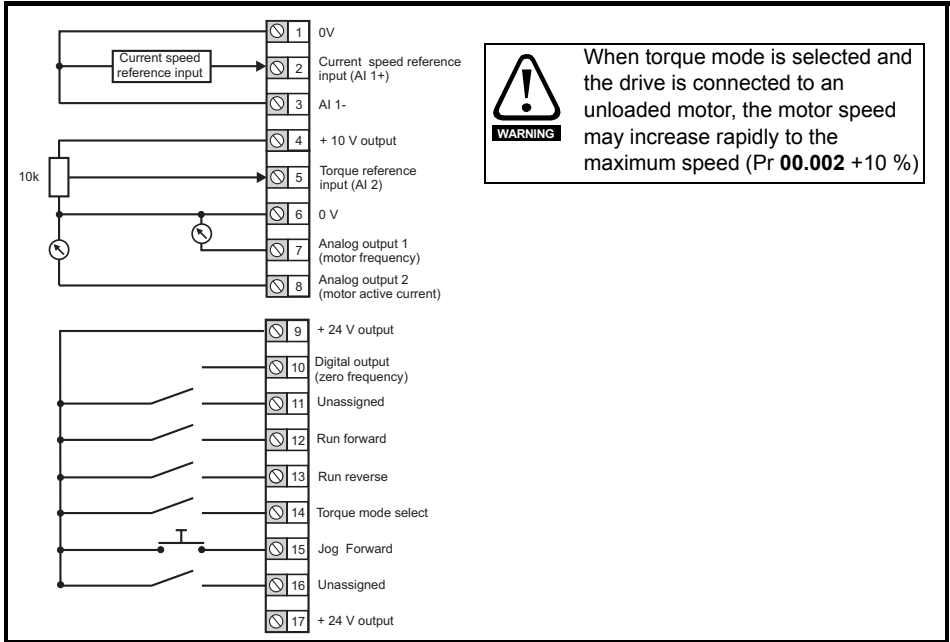
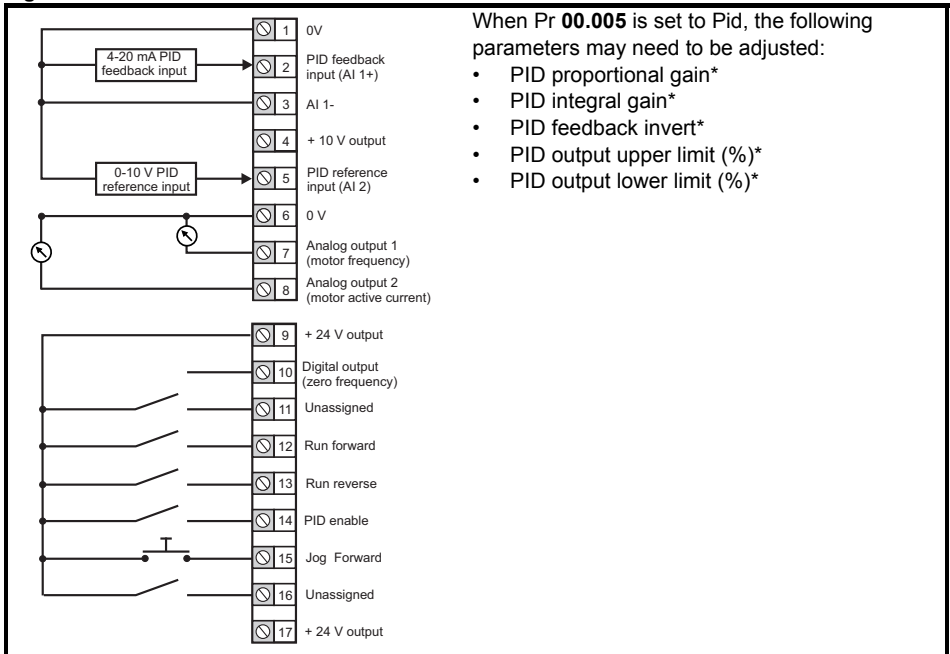

Figure 4-10 Pr 00.005 = PID Control



* Refer to the *Control User Guide*.

4.2 Safe Torque Off (STO)

The Safe Torque Off function provides a means for preventing the drive from generating torque in the motor with a very high level of integrity. It is suitable for incorporation into a safety system for a machine. It is also suitable for use as a conventional drive enable input.

The safety function is active when either one or both STO inputs are in the logic-low state as specified in the control terminal specification. The function is defined according to EN 61800-5-2 and IEC 61800-5-2 as follows. (In these standards a drive offering safety-related functions is referred to as a PDS(SR)):

'Power, that can cause rotation (or motion in the case of a linear motor), is not applied to the motor. The PDS(SR) will not provide energy to the motor which can generate torque (or force in the case of a linear motor).'

This safety function corresponds to an uncontrolled stop in accordance with stop category 0 of IEC 60204-1. The Safe Torque Off function makes use of the special property of an inverter drive with an induction motor, which is that torque cannot be generated without the continuous correct active behavior of the inverter circuit. All credible faults in the inverter power circuit cause a loss of torque generation.

The Safe Torque Off function is fail-safe, so when the Safe Torque Off input is disconnected the drive will not operate the motor, even if a combination of components within the drive has failed. Most component failures are revealed by the drive failing to operate. Safe Torque Off is also independent of the drive firmware.



The design of safety-related control systems must only be done by personnel with the required training and experience. The Safe Torque Off function will only ensure the safety of a machine if it is correctly incorporated into a complete safety system. The system must be subject to a risk assessment to confirm that the residual risk of an unsafe event is at an acceptable level for the application.



Safe Torque Off does not provide electrical isolation. The supply to the drive must be disconnected by an approved isolation device before gaining access to power connections.



It is essential to observe the maximum permitted voltage of 5 V for a safe low (disabled) state of Safe Torque Off. The connections to the drive must be arranged so that voltage drops in the 0 V wiring cannot exceed this value under any loading condition. It is strongly recommended that the Safe Torque Off circuits be provided with a dedicated 0 V conductors which should be connected to terminals 32 and 36 at the drive.

Figure 4-11 Frame 1 to 4 STO connections

Figure 4-12 Frame 5 and above STO connections

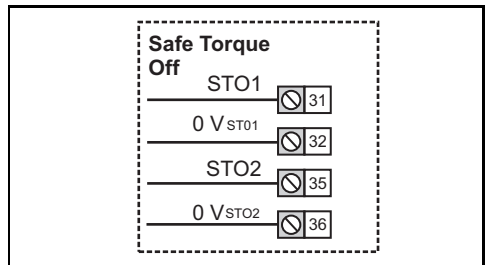
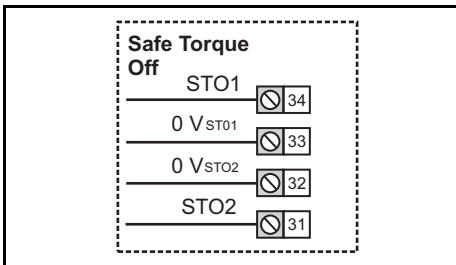

NOTE**Frame 1 to 4**

The 0 V terminals on the Safe Torque Off are isolated from each other and the 0 V common. On the size 2 110 V drives or when connecting single phase to a dual rated 200 V unit, the supply should be connected to L1 and L3.

NOTE**Frames 5 and above**

The 0 V terminals on the Safe Torque Off are not isolated from each other and the 0 V common.

5 Optional LCD keypad and display

The keypad and display provide information to the user regarding the operating status of the drive, alarms and trip codes, and provide the means for changing parameters, stopping and starting the drive, and the ability to perform a drive reset.

Figure 5-1 Unidrive M400 keypad detail

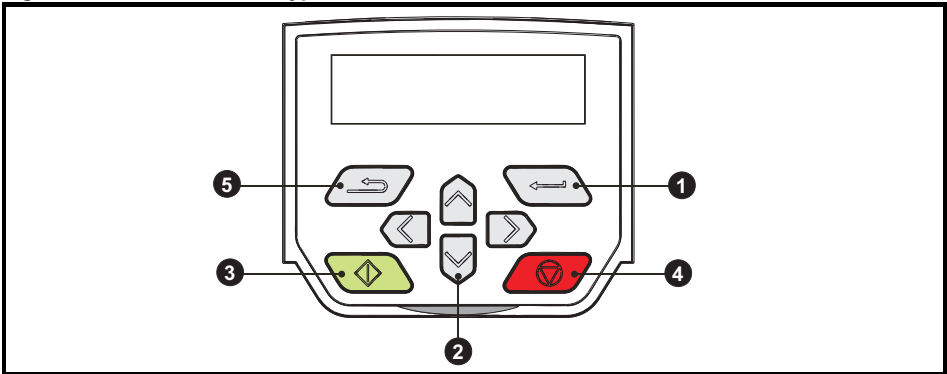

- (1) The *Enter* button is used to enter parameter view or edit mode, or to accept a parameter edit.
- (2) The *Navigation* buttons can be used to select individual parameters or to edit parameter values. In keypad mode, the '*Up*' and '*Down*' buttons are also used to increase or decrease the motor speed.
- (3) The *Start* button (green) is used to start the drive in keypad mode.
- (4) The *Stop / Reset* button (red) is used to stop and reset the drive in keypad mode. It can also be used to reset the drive in terminal mode.
- (5) The *Escape* button is used to exit from the parameter edit / view mode or disregard a parameter edit.

NOTE

The keypad is not supplied with the drive.

NOTE

It is possible to display alternative parameters on the multi line LCD display such as current magnitude. Refer to the *Control User Guide* for further information.

Table 5-2 Status indications

Upper row string	Description	Drive output stage
Inhibit	The drive is inhibited and cannot be run. The Safe Torque Off signal is not applied to Safe Torque Off terminals or is set to 0.	Disabled
Ready	The drive is ready to run. The drive enable is active, but the drive inverter is not active because the final drive run is not active.	Disabled
Stop	The drive is stopped / holding zero frequency.	Enabled
Run	The drive is active and running.	Enabled
Supply Loss	Supply loss condition has been detected	Enabled
Deceleration	The motor is being decelerated to zero frequency because the final drive run has been deactivated.	Enabled
dc Injection	The drive is applying DC injection braking.	Enabled
Trip	The drive has tripped and no longer controlling the motor. The trip code appears in the lower display.	Disabled
Under Voltage	The drive is in the under voltage state either in low voltage or high voltage mode.	Disabled
Heat	The motor pre-heat function is active	Enabled

5.1 Saving parameters

When changing a parameter in Menu 0, the new value is saved when pressing the Enter button



to return to parameter view mode from parameter edit mode.

If parameters have been changed in the advanced menus, then the change will not be saved automatically. A save function must be carried out.

Procedure

1. Select 'Save parameters' in Pr **mm.000** (alternatively enter a value of 1001 in Pr **mm.000**)
2. Either:
 - Press the red  reset button
 - Carry out a drive reset through serial communications by setting Pr **10.038** to 100

5.2 Restoring parameter defaults

Restoring parameter defaults by this method saves the default values in the drives memory. *User security status* (00.010) and *User security code* (00.025) are not affected by this procedure).

Procedure

1. Ensure the drive is not enabled, i.e. drive is in inhibit or under voltage state.
2. Select 'Reset 50 Hz Defs' or 'Reset 60 Hz Defs' in Pr **mm.000**. (alternatively, enter 1233 (50 Hz settings) or 1244 (60 Hz settings) in Pr **mm.000**).
3. Either:
 - Press the red  reset button
 - Carry out a drive reset through serial communications by setting Pr **10.038** to 100

6 Basic parameters (Menu 0)

Menu 0 is used to bring together various commonly used parameters for basic easy set up of the drive.

6.1 Menu 0: Basic parameters

Parameter	Range (⇕)		Default (⇔)		Type					
	OL	RFC-A	OL	RFC-A						
00.001	Minimum Speed	0.00 to Pr 00.002 Hz		0.00 Hz		RW	Num			US
00.002	Maximum Speed	0.00 to 550.00 Hz		50Hz default: 50.00 Hz 60Hz default: 60.00 Hz		RW	Num			US
00.003	Acceleration Rate 1	0.0 to 32000.0 s/100 Hz		5.0 s/100 Hz		RW	Num			US
00.004	Deceleration Rate 1	0.0 to 32000.0 s/100 Hz		10.0 s/100 Hz		RW	Num			US
00.005	Drive Configuration	AV (0), AI (1), AV Preset (2), AI Preset (3), Preset (4), Keypad (5), Keypad Ref (6), Electronic Pot (7), Torque Control (8), Pid Control (9)		AV (0)		RW	Txt			PT US
00.006	Motor Rated Current	0.00 to Drive Rating A		Maximum Heavy Duty Rating A		RW	Num		RA	US
00.007	Motor Rated Speed*	0.0 to 33000.0 rpm		50Hz default: 1500.0 rpm 60Hz default: 1800.0 rpm	50Hz default: 1450.0 rpm 60Hz default: 1750.0 rpm	RW	Num			US
00.008	Motor Rated Voltage	0 to 765 V		200V drive: 230 V 400V drive 50 Hz: 400 V 400V drive 60 Hz: 460 V 575 V drive: 575 V 690 V drive: 690 V		RW	Num		RA	US
00.009	Motor Rated Power Factor**	0.00 to 1.00		0.85		RW	Num		RA	US
00.010	User Security Status	Level 1 (0), Level 2 (1), All Menus (2), Status Only (3), No Access (4)		Level 1 (0)		RW	Num	ND		PT
00.011	Start/Stop Logic Select	0 to 6		5		RW	Num			US
00.012	Input Logic Polarity	Negative Logic (0) or Positive Logic (1)		Positive Logic (1)		RW	Txt			US
00.015	Jog Reference	0.00 to 300.00 Hz		1.50 Hz		RW	Num			US
00.016	Analog Input 1 Mode	4-20 mA Stop (-6), 20-4 mA Stop (-5), 4-20 mA Low (-4), 20-4 mA Low (-3), 4-20 mA Hold (-2), 20-4 mA Hold (-1), 0-20 mA (0), 20-0 mA (1), 4-20 mA Trp (2), 20-4 mA Trp (3), 4-20 mA (4), 20-4 mA (5), Voltage (6)		Voltage (6)		RW	Txt			US
00.017	Bipolar Reference Enable	Off (0) or On (1)		Off (0)		RW	Bit			US
00.018	Preset Reference 1	0.00 to Pr 00.002 Hz		0.00 Hz		RW	Num			US
00.019	Preset Reference 2	0.00 to Pr 00.002 Hz		0.00 Hz		RW	Num			US
00.020	Preset Reference 3	0.00 to Pr 00.002 Hz		0.00 Hz		RW	Num			US
00.021	Preset Reference 4	0.00 to Pr 00.002 Hz		0.00 Hz		RW	Num			US
00.022	Status Mode Parameter 2	0.000 to 30.999		4.020		RW	Num			PT US
00.023	Status Mode Parameter 1	0.000 to 30.999		2.001		RW	Num			PT US

Parameter		Range (⇄)		Default (⇨)		Type					
		OL	RFC-A	OL	RFC-A						
00.024	Customer Defined Scaling	0.000 to 10.000		1.000		RW	Num				US
00.025	User Security Code	0 to 9999		0		RW	Num	ND		PT	US
00.027	Power-up Keypad Control Mode Reference	Reset (0), Last (1), Preset (2)		Reset (0)		RW	Txt				US
00.028	Ramp Mode Select	Fast (0), Standard (1), Std boost (2), Fast boost (3)		Standard (1)		RW	Txt				US
00.029	Ramp Enable		Off (0) or On (1)		On (1)	RW	Bit				US
00.030	Parameter Cloning	None (0), Read (1), Program (2), Auto (3), Boot (4)		None (0)		RW	Txt		NC		US
00.031	Stop Mode	Coast (0), Ramp (1), Ramp dc I (2), dc I (3), Timed dc I (4), Disable (5)	Coast (0), Ramp (1), Ramp dc I (2), dc I (3), Timed dc I (4), Disable (5), No Ramp (6)	Ramp (1)		RW	Txt				US
00.032	Dynamic V to F Select / Flux Optimization Select	0 to 1		0		RW	Num				US
00.033	Catch A Spinning Motor	Disable (0), Enable (1), Fwd Only (2), Rev Only (3)		Disable (0)		RW	Txt				US
00.034	Digital Input 5 Select	Input (0), Therm Short Cct (1), Thermistor (2), Therm No Trip (3)		Input (0)		RW	Txt				US
00.035	Digital Output 1 Control	0 to 21		0		RW	Num				US
00.036	Analog Output 1 Control	0 to 14		0		RW	Txt				US
00.037	Maximum Switching Frequency	0.667 (0), 1 (1), 2 (2), 3 (3), 4 (4), 6 (5), 8 (6), 12 (7), 16 (8) kHz	2 (2), 3 (3), 4 (4), 6 (5), 8 (6), 12 (7), 16 (8) kHz	3 (3) kHz		RW	Txt				US
00.038	Autotune	0 to 2	0 to 3	0		RW	Num		NC		US
00.039	Motor Rated Frequency	0.00 to 550.00 Hz		50Hz: 50.00 Hz 60Hz: 60.00 Hz		RW	Num				US
00.040	Number of Motor Poles***	Auto (0) to 32 (16)		Auto (0)		RW	Num				US
00.041	Control Mode	Ur S (0), Ur (1), Fixed (2), Ur Auto (3), Ur I (4), Square (5), Fixed Tapered (6)		Ur I (4)		RW	Txt				US
00.042	Low Frequency Voltage Boost	0.0 to 25.0 %		3.0 %		RW	Num				US
00.043	Serial Baud Rate	600 (1), 1200 (2), 2400 (3), 4800 (4), 9600 (5), 19200 (6), 38400 (7), 57600 (8), 76800 (9), 115200 (10)		19200 (6)		RW	Txt				US
00.044	Serial Address	1 to 247		1		RW	Num				US
00.045	Reset Serial Communications	Off (0) or On (1)		Off (0)		RW		ND	NC		US
00.046	Brake Controller Upper Current Threshold	0 to 200 %		50 %		RW	Num				US
00.047	Brake Controller Lower Current Threshold	0 to 200 %		10 %		RW	Num				US

Parameter		Range (ϕ)		Default (⇒)		Type						
		OL	RFC-A	OL	RFC-A							
00.048	Brake Controller Brake Release Frequency	0.00 to 20.00 Hz		1.00 Hz		RW	Num					US
00.049	Brake Controller Brake Apply Frequency	0.00 to 20.00 Hz		2.00 Hz		RW	Num					US
00.050	Brake Controller Brake Delay	0.0 to 25.0 s		1.0 s		RW	Num					US
00.051	Brake Controller Post-brake Release Delay	0.0 to 25.0 s		1.0 s		RW	Num					US
00.053	Brake Controller Initial Direction	Ref (0), Forward (1), Reverse (2)		Ref (0)		RW	Txt					US
00.054	Brake Controller Brake Apply Through Zero Threshold	0.00 to 25.00 Hz		1.00 Hz		RW	Num					US
00.055	Brake Controller Enable	Disable (0), Relay (1), Digital IO (2), User (3)		Disable (0)		RW	Txt					US
00.056	Trip 0	0 to 255				RO	Txt	ND	NC	PT	PS	
00.057	Trip 1	0 to 255				RO	Txt	ND	NC	PT	PS	
00.058	Trip 2	0 to 255				RO	Txt	ND	NC	PT	PS	
00.059	OUP Enable	Stop (0) or Run (1)		Run (1)		RW	Txt					US
00.060	OUP Status	-2147483648 to 2147483647				RO	Num	ND	NC	PT		
00.065	Frequency Controller Proportional Gain Kp1		0.000 to 200.000 s/rad		0.100 s/rad	RW	Num					US
00.066	Frequency Controller Integral Gain Ki1		0.00 to 655.35 s ² /rad		0.10 s ² /rad	RW	Num					US
00.067	Sensorless Mode Filter		4 (0), 5 (1), 6 (2), 8 (3), 12 (4), 20 (5) ms		4 (0) ms	RW	Txt					US
00.069	Spin Start Boost	0.0 to 10.0		1.0		RW	Num					US
00.070	PID1 Output	±100.00 %				RO	Num	ND	NC	PT		
00.071	PID1 Proportional Gain	0.000 to 4.000		1.000		RW	Num					US
00.072	PID1 Integral Gain	0.000 to 4.000		0.500		RW	Num					US
00.073	PID1 Feedback Invert	Off (0) or On (1)		Off (0)		RW	Bit					US
00.074	PID1 Output Upper Limit	0.00 to 100.00 %		100.00 %		RW	Num					US
00.075	PID1 Output Lower Limit	±100.00 %		-100.00 %		RW	Num					US
00.076	Action on Trip Detection	0 to 31		0		RW	Num	ND	NC	PT	US	
00.077	Maximum Heavy Duty Current Rating	0.00 to Drive HD Current Rating A				RO	Num	ND	NC	PT		
00.078	Software Version	0 to 99.99.99.99				RO	Num	ND	NC	PT		
00.079	User Drive Mode	Open loop (1), RFC A (2)		Open loop (1)	RFC-A (2)	RW	Txt	ND	NC	PT	US	
00.081	Reference Selected	-Pr 00.002 to Pr 00.002 or Pr 00.001 to Pr 00.002 Hz				RO	Num	ND	NC	PT		
00.082	Pre-ramp Reference	-Pr 00.002 to Pr 00.002 or Pr 00.001 to Pr 00.002 Hz				RO	Num	ND	NC	PT		
00.083	Final Demand Reference	-Pr 00.002 to Pr 00.002 or Pr 00.001 to Pr 00.002 Hz				RO	Num	ND	NC	PT	FI	
00.084	D.C. Bus Voltage	0 to 1190 V				RO	Num	ND	NC	PT	FI	
00.085	Output Frequency	±550.00 Hz				RO	Num	ND	NC	PT	FI	

Parameter	Range (⚡)		Default (⇔)		Type						
	OL	RFC-A	OL	RFC-A							
00.086	Output Voltage	0 to 930 V				RO	Num	ND	NC	PT	FI
00.087	Motor Rpm	±33000.0 rpm				RO	Num	ND	NC	PT	FI
00.088	Current Magnitude	0 to Drive Maximum Current A				RO	Num	ND	NC	PT	FI
00.089	Torque Producing Current	±Drive Maximum Current A				RO	Num	ND	NC	PT	FI
00.090	Digital I/O Read Word	000000000000 to 111111111111				RO	Bin	ND	NC	PT	
00.091	Reference On	Off (0) or On (1)				RO	Bit	ND	NC	PT	
00.092	Reverse Select	Off (0) or On (1)				RO	Bit	ND	NC	PT	
00.093	Jog Select	Off (0) or On (1)				RO	Bit	ND	NC	PT	
00.094	Analog Input 1	±100.00 %				RO	Num	ND	NC	PT	FI
00.095	Analog Input 2	±100.00 %				RO	Num	ND	NC	PT	FI

* Setting Pr 00.007 to 0.0 will disable slip compensation.

** Following a rotating autotune, Pr 00.009 is continuously written to by the drive, calculated from the value of *Stator Inductance* (Pr 05.025). To manually enter a value into Pr 00.009, Pr 05.025 will need to be set to 0. Refer to the description of Pr 05.010 in the *Parameter Reference Guide* for further details.

*** If this parameter is read via serial communications, it will show pole pairs.

RW	Read / Write	RO	Read only	Num	Number parameter	Bit	Bit parameter	Txt	Text string	Bin	Binary parameter	FI	Filtered
ND	No default value	NC	Not copied	PT	Protected parameter	RA	Rating dependent	US	User save	PS	Power-down save	DE	Destination

Figure 6-1 Menu 0 logic diagram

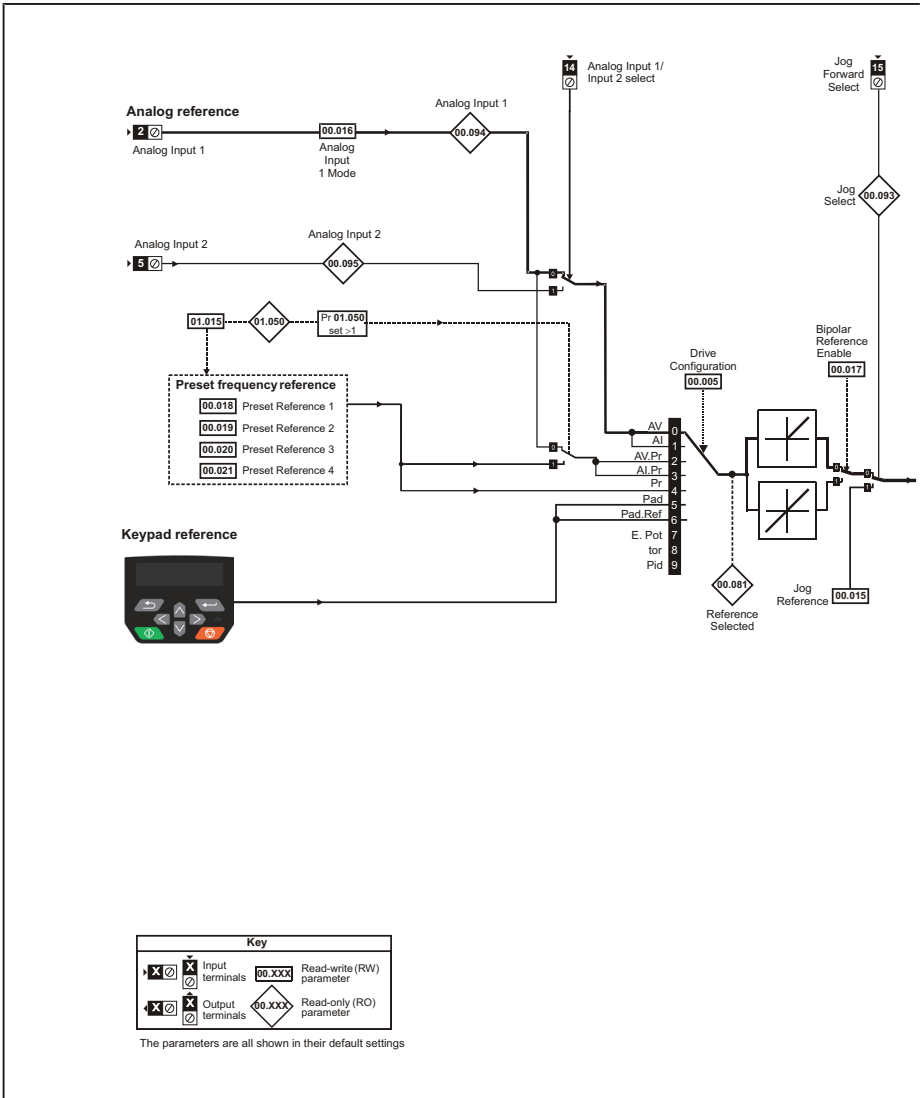

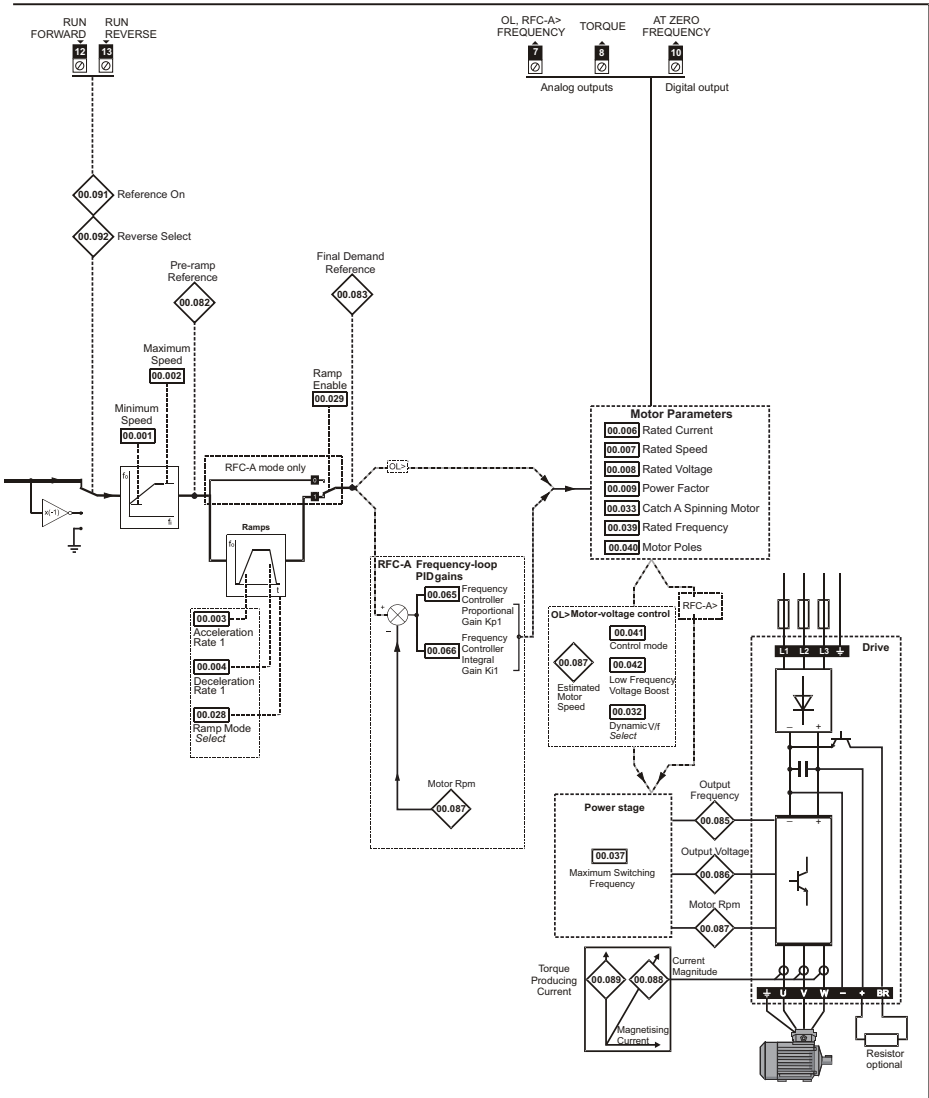

6.2 Unidrive M400 parameter descriptions

Key:

RW	Read / Write	RO	Read only	Num	Number parameter	Bit	Bit parameter	Txt	Text string	Bin	Binary parameter	FI	Filtered
ND	No default value	NC	Not copied	PT	Protected parameter	RA	Rating dependent	US	User save	PS	Power-down save	DE	Destination

00.001		Minimum Speed											
RW		Num										US	
OL	⇕	0.00 to Pr 00.002 Hz					⇒	0.00 Hz					
RFC-A													

Set Pr **00.001** at the required minimum output frequency of the drive for both directions of rotation. The drive speed reference is scaled between Pr **00.001** and Pr **00.002**. Pr **00.001** is a nominal value; slip compensation may cause the actual frequency to be higher. When the drive is jogging, Pr **00.001** has no effect.

00.002		Maximum Speed											
RW		Num										US	
OL	⇕	0.00 to 550.00 Hz					⇒	50.0 Hz default: 50.00 Hz 60.0 Hz default: 60.00 Hz					
RFC-A													

Set Pr **00.002** at the required maximum output frequency for both directions of rotation. The drive speed reference is scaled between Pr **00.001** and Pr **00.002**. Pr **00.002** is a nominal value; slip compensation may cause the actual frequency to be higher. The drive has additional over-speed protection.

00.003		Acceleration Rate 1											
RW		Num										US	
OL	⇕	0.0 to 32000.0 s/100 Hz					⇒	5.0 s/100 Hz					
RFC-A													

Set Pr **00.003** at the required rate of acceleration. Note that larger values produce lower acceleration. The rate applies in both directions of rotation.

00.004		Deceleration Rate 1							
RW	Num							US	
OL	⇕	0.0 to 32000.0 s/100 Hz			⇒	10.0 s/100 Hz			
RFC-A									

Set Pr **00.004** at the required rate of deceleration. Note that larger values produce lower deceleration. The rate applies in both directions of rotation.

00.005		Drive Configuration							
RW	Txt							PT	US
OL	⇕	AV (0), AI (1), AV Preset (2), AI Preset (3), Preset (4), Keypad (5), Keypad Ref (6), Electronic Pot (7), Torque Control (8), Pid Control (9)			⇒	AV (0)			

Use Pr **00.005** to select the required frequency/speed reference as follows:

Value	Text	Description
0	AV	Analog Input 1 (voltage) or Analog Input 2 (voltage) selected by terminal (Local/Remote)
1	AI	Analog Input 1 (current) or Analog Input 2 (voltage) selected by terminal (Local/Remote)
2	AV Preset	Analog Input 1 (voltage) or 3 presets selected by terminal
3	AI Preset	Analog Input 1 (current) or 3 presets selected by terminal
4	Preset	Four presets selected by terminal
5	Keypad	Keypad reference
6	Keypad Ref	Keypad reference with terminal control
7	Electronic Pot	Electronic Potentiometer
8	Torque Control	Torque mode, Analog Input 1 (current frequency reference) or Analog Input 2 (voltage torque reference) selected by terminal
9	Pid Control	PID mode, Analog Input 1 (current feedback source) and Analog Input 2 (voltage reference source)

NOTE A change to Pr **00.005** is set by pressing the ENTER button on exit from parameter edit mode. The drive must be disabled, stopped or tripped for a change to take place. If Pr **00.005** is changed while the drive is running, when the ENTER button is pressed on exit from parameter edit mode, Pr **00.005** will change back to its previous value.

NOTE When the setting of Pr **00.005** is changed, the appropriate drive configuration parameters are set back to their default values.

00.006		Motor Rated Current								
RW		Num					RA		US	
OL	⇕	0.00 to Drive Rating A				⇒	Maximum Heavy Duty Rating A			
RFC-A										

The rated current parameter must be set to the maximum continuous current of the motor (taken from the name plate). The motor rated current is used in the following:

- Current limits
- Motor thermal overload protection
- Vector mode voltage control
- Slip compensation
- Dynamic V/F control

00.007		Motor Rated Speed								
RW		Num							US	
OL	⇕	0.0 to 33000.0 rpm				⇒	50 Hz default: 1500.0 rpm			
RFC-A							60 Hz default: 1800.0 rpm			
						50 Hz default: 1450.0 rpm				
						60 Hz default: 1750.0rpm				

Set to the rated speed of the motor (taken from the motor name plate). The motor rated speed is used to calculate the correct slip speed for the motor.

00.008		Motor Rated Voltage								
RW		Num					RA		US	
OL	⇕	0 to 765 V				⇒	200 V drive: 230 V			
RFC-A							400 V drive 50 Hz: 400 V			
						400 V drive 60 Hz: 460 V				
						575 V drive: 575 V				
						690 V drive: 690 V				

The *Rated Voltage* (00.008) and the *Rated Frequency* (00.039) are used to define the voltage to frequency characteristic applied to the motor. The *Rated Frequency* (00.039) is also used in conjunction with the *Motor Rated Speed* (00.007) to calculate the rated slip for slip compensation.

00.009		Motor Rated Power Factor								
RW		Num					RA		US	
OL	⇕	0.00 to 1.00				⇒	0.85			
RFC-A										

Enter the motor rated power factor $\cos \varphi$ (taken from the motor name plate).

The drive can measure the motor rated power factor by performing a rotating autotune (see Autotune (Pr 00.038)).

00.010		User Security Status							
RW	Num				ND	NC	PT	US	
OL	⇕	Level 1 (0), Level 2 (1), All Menus (2), Status Only (3), No Access (4)			⇒	Level 1 (0)			
RFC-A									

This parameter controls access via the drive keypad as follows:

Value	Text	Function
0	Level 1	Access to first 10 parameters in Menu 0 only.
1	Level 2	Access to all parameters in Menu 0.
2	All Menus	Access to all menus.
3	Status Only	The keypad remains in status mode and no parameters can be viewed or edited.
4	No Access	The keypad remains in status mode and no parameters can be viewed or edited. Drive parameters cannot be accessed via a comms/fieldbus interface in the drive or any option module.

00.011		Start/Stop Logic Select							
RW	Num							US	
OL	⇕	0 to 6			⇒	5			
RFC-A									

This parameter changes the functions of the input terminals which are normally associated with the enabling, starting and stopping the drive.

Pr 00.011	Terminal 11	Terminal 12	Terminal 13	Latching
0	User programmable	Run Forward	Run Reverse	No
1	/Stop	Run Forward	Run Reverse	Yes
2	User programmable	Run	Forward/Reverse	No
3	/Stop	Run	Forward/Reverse	Yes
4	/Stop	Run	Jog Forward	Yes
5	User programmable	Run Forward	Run Reverse	No
6	User programmable	User programmable	User programmable	User programmable

Action will only occur if the drive is inactive. If the drive is active, the parameter will return to its pre-altered value on exit from edit mode.

00.012		Input Logic Polarity								
RW		Txt						US		
OL	⇕	Negative Logic (0) or Positive Logic (1)				⇒	Positive Logic (1)			
RFC-A										

Can be set to zero to change the logic for DI/O1-7 to negative logic, so that the state parameter is 0 if the digital I/O is high or 1 if the digital I/O is low.

00.015		Jog Reference								
RW		Num						US		
OL	⇕	0.00 to 300.00 Hz				⇒	1.50 Hz			
RFC-A										

Defines the reference when jog is enabled.

00.016		Analog Input 1 Mode								
RW		Txt						US		
OL	⇕	4-20 mA Stop (-6), 20-4 mA Stop (-5), 4-20 mA Low (-4), 20-4 mA Low (-3), 4-20 mA Hold (-2), 20-4 mA Hold (-1), 0-20 mA (0), 20-0 mA (1), 4-20 mA Trp (2), 20-4 mA Trp (3), 4-20 mA (4), 20-4 mA (5), Voltage (6)				⇒	Voltage (6)			
RFC-A										

Defines the mode of analog input 1.

The table below gives all the possible analog input modes.

Value	Text	Function
-6	4-20 mA Stop	Stop on loss
-5	20-4 mA Stop	Stop on loss
-4	4-20 mA Low	4-20 mA switching to equivalent of 4 mA input current on loss
-3	20-4 mA Low	20-4 mA switching to equivalent of 20 mA input current on loss
-2	4-20 mA Hold	4-20 mA hold at level before loss on loss
-1	20-4 mA Hold	20-4 mA hold at level before loss on loss
0	0-20 mA	0-20 mA
1	20-0 mA	20-0 mA
2	4-20 mA Trp	4-20 mA trip on loss
3	20-4 mA Trp	20-4 mA trip on loss
4	4-20 mA	4-20 mA no action on loss
5	20-4 mA	20-4 mA no action on loss
6	Voltage	Voltage

NOTE In 4-20 mA and 20-4 mA modes loss of input is detected if the current falls below 3 mA.

NOTE If both analog inputs (A1 and A2) are to be set-up as voltage inputs, and if the potentiometers are supplied from the drive's +10 V rail (terminal T4), they must have a resistance >4 k Ω each.

00.017		Bipolar Reference Enable								
RW	Bit							US		
OL	⇕	Off (0) or On (1)				⇒	Off (0)			
RFC-A										

Pr **00.017** determines whether the reference is uni-polar or bi-polar.

See *Minimum Speed* (00.001). Allows negative speed reference in keypad mode.

00.018 to 00.021		Preset Reference 1 to 4								
RW	Num							US		
OL	⇕	0.0 to Pr 00.002 Hz				⇒	0.00 Hz			
RFC-A										

If the preset reference has been selected (see Pr **00.005**), the speed at which the motor runs is determined by these parameters.

See *Drive Configuration* (00.005).

00.022		Status Mode Parameter 2								
RW	Num							PT	US	
OL	⇕	0.000 to 30.999				⇒	4.020			
RFC-A										

This parameter and *Status Mode Parameter 1* (00.023) define which parameters are displayed in Status mode. The values can be alternated by pressing the Escape key, if the drive is running.

00.023		Status Mode Parameter 1								
RW	Num							PT	US	
OL	⇕	0.000 to 30.999				⇒	2.001			
RFC-A										

See *Status Mode Parameter 2* (00.022).

00.024		Customer Defined Scaling								
RW	Num							US		
OL	⇕	0.000 to 10.000				⇒	1.000			
RFC-A										

This parameter defines the scaling applied to *Status Mode Parameter 1* (00.023). The scaling is only applied in the Status mode.

00.025		User Security Code								
RW	Num				ND	NC	PT	US		
OL	⇕	0-9999				⇒	0			
RFC-A										

If any number other than 0 is programmed into this parameter, user security can be applied so that no parameters except Pr **00.010** can be adjusted with the keypad. When this parameter is read via a keypad it appears as zero. Refer to the *Control User Guide* for further information.

00.027		Power-up Keypad Control Mode Reference								
RW	Txt				ND	NC	PT	US		
OL	⇕	Reset (0), Last (1), Preset (2)				⇒	Reset (0)			
RFC-A										

Defines which value of keypad control mode reference is displayed at power-up.

Value	Text	Description
0	Reset	Keypad reference is zero
1	Last	Keypad reference is the last used value
2	Preset	Keypad reference is copied from <i>Preset Reference 1</i> (00.018)

00.028		Ramp Mode Select								
RW	Txt							US		
OL	⇕	Fast (0), Standard (1), Std boost (2), Fast boost (3)				⇒	Standard (1)			
RFC-A										

Defines the mode used by the ramp system.

- 0: Fast ramp
- 1: Standard ramp
- 2: Standard ramp with motor voltage boost
- 3: Fast ramp with motor voltage boost

Fast ramp is linear deceleration at programmed rate, normally used when a braking resistor is installed.

Standard ramp is controlled deceleration to prevent DC bus over-voltage trips, normally used when there is no braking resistor installed.

If a high motor voltage mode is selected, deceleration rates can be faster for a given inertia but motor temperatures will be higher.

00.029		Ramp Enable								
RW	Bit							US		
OL	⇕					⇒				
RFC-A		Off (0) or On (1)					On (1)			

Setting Pr **00.029** to 0 allows the user to disable the ramps. This is generally used when the drive is required to closely follow a speed reference which already contains acceleration and deceleration ramps.

00.030		Parameter Cloning								
RW	Txt					NC		US*		
OL	⇕	None (0), Read (1), Program (2), Auto (3), Boot (4)				⇒	None (0)			
RFC-A										

* Only a value of 3 or 4 in this parameter is saved.

If Pr **00.030** is equal to 1 or 2, this value is not transferred to the EEPROM or the drive. If Pr **00.030** is set to a 3 or 4 the value is transferred.

Parameter string	Parameter value	Comment
None	0	Inactive
Read	1	Read parameter set from the NV Media Card
Program	2	Programming a parameter set to the NV Media Card
Auto	3	Auto save
Boot	4	Boot mode

For further information, please refer to Chapter 8 *Diagnostics* on page 52.

00.031		Stop Mode								
RW	Txt							US		
OL	⇕	Coast (0), Ramp (1), Ramp dc I (2), dc I (3), Timed dc I (4), Disable (5)				⇒	Ramp (1)			
RFC-A		Coast (0), Ramp (1), Ramp dc I (2), dc I (3), Timed dc I (4), Disable (5), No Ramp (6)								

Defines how the motor is controlled when the run signal is removed from the drive.

Value	Text	Description
0	Coast	Coast stop
1	Ramp	Ramp stop
2	Ramp dc I	Ramp stop + 1 second dc injection
3	dc I	Injection braking stop with detection of zero speed
4	Timed dc I	Timed injection braking stop
5	Disable	Disable
6	No Ramp	No ramp (RFC-A mode only)

See the *Control User Guide* for further information.

00.032		Dynamic V To F Select / Flux Optimisation Select							
RW	Num							US	
OL	⇕	0 to 1			⇒	0			
RFC-A									

Open loop:

Set to 1 to enable Dynamic V to F mode.

0: Fixed linear voltage to frequency ratio (constant torque - standard load)

1: Voltage to frequency ratio dependant on load current. This gives a higher motor efficiency.

RFC-A:

If this parameter is set to 1, the flux is reduced so that the magnetizing current is equal to the torque producing current, to optimize copper losses and reduce iron losses in the motor under low load conditions.

00.033		Catch a Spinning Motor							
RW	Txt							US	
OL	⇕	Disable (0), Enable (1), Fwd Only (2), Rev Only (3)			⇒	Disable (0)			
RFC-A									

If the drive is to be configured in fixed boost mode (Pr **00.041** = Fd or SrE) with catch a spinning motor software enabled, an autotune (see Pr **00.038** on page 38) must be carried out to measure the motor's stator resistance beforehand. If a stator resistance is not measured, the drive may trip on Over Volts or OI ac while trying to catch a spinning motor.

Pr 00.033	Text	Function
0	Disable	Disabled
1	Enable	Detect all frequencies
2	Fwd Only	Detect positive frequencies only
3	Rev Only	Detect negative frequencies only

00.034		Digital Input 5 Select							
RW	Txt							US	
OL	↕	Input (0), Therm Short Cct (1), Thermistor (2), Therm No Trip (3)			⇒	Input (0)			
RFC-A									

This parameter selects the function of Digital Input 5 (terminal 14).

Value	Text	Function
0	Input	Digital input
1	Therm Short Cct	Temperature measurement input with short circuit detection (Resistance <50 Ω)
2	Thermistor	Temperature measurement input without short circuit detection but with th trip
3	Therm No Trip	Temperature measurement input with no trips

Figure 6-1 Thermistor input

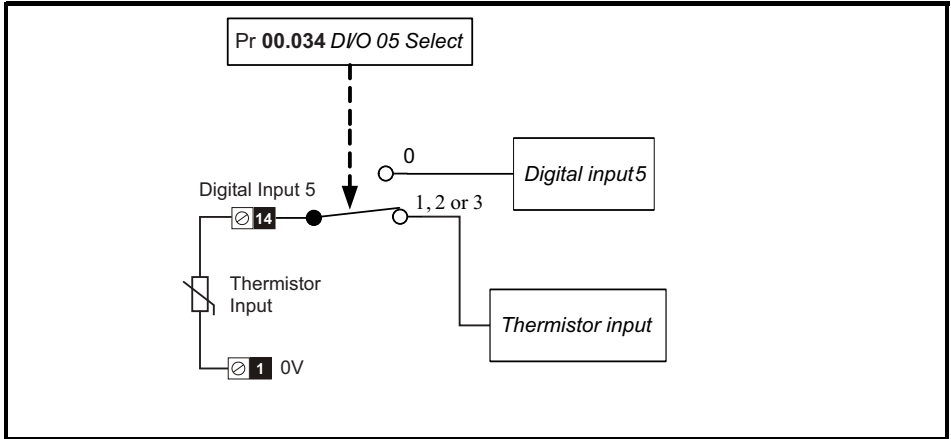

00.035		DO1 Control							
RW	Num							US	
OL	↕	0-21			⇒	0			
RFC-A									

Defines the behaviour of digital output 1 (terminal 10).

Value	Description
0	User defined by Digital IO1 Source/Destination A
1	Drive running signal
2	Frequency arrived signal
3	Frequency level detection signal
4	Frequency level detection signal
5	Overload detection signal
6	Power off state
7	External fault stop
8	Frequency upper limit
9	Frequency lower limit
10	Drive running at zero frequency
14	Drive Ready
15	Drive OK
18	Brake release
19	Torque limiting (Valid while the torque is limited by torque limiting value 1/2)
20	Forward or reverse
21	Motor 1 or 2

00.036		Analog Output 1 Control								
RW		Txt							US	
OL	⇕	0 to 14					⇒	0		
RFC-A										

Defines the functionality of Analog Output 1 (terminal 7).

Value	Description
0	User defined by Analog Output 1 Source A
1	Frequency output
2	Frequency reference
3	Motor speed
4	Current Magnitude
6	Torque output
7	Torque current output
8	Voltage output
9	DC bus voltage (0~800 V)
10	Analog Input 1
11	Analog Input 2
12	Power output (0~2 x Pe)
13	Torque limitation
14	Torque reference (0~300 %)

00.037		Maximum Switching Frequency								
RW		Txt							US	
OL	⇕	0.667 (0), 1 (1), 2 (2), 3 (3), 4 (4), 6 (5), 8 (6), 12 (7), 16 (8) kHz					⇒	3 (3) kHz		
RFC-A		2 (2), 3 (3), 4 (4), 6 (5), 8 (6), 12 (7), 16 (8) kHz								

Defines the maximum switching frequency that can be used by the drive.

Pr 00.037	Text	Description
0	0.667	667 Hz switching frequency
1	1	1 kHz switching frequency
2	2	2 kHz switching frequency
3	3	3 kHz switching frequency
4	4	4 kHz switching frequency
5	6	6 kHz switching frequency
6	8	8 kHz switching frequency
7	12	12 kHz switching frequency
8	16	16 kHz switching frequency

See the *Power Installation Guide* for drive derating data.

00.038		Autotune								
RW		Num					NC		US	
OL	⇕	0 to 2				⇒	0			
RFC-A		0 to 3								

Defines the auto-tune test to be performed.

There are two autotune tests available in open loop mode, a stationary and a rotating test. A rotating autotune should be used whenever possible so the measured value of power factor of the motor is used by the drive.

Open Loop and RFC-A:

1. A stationary autotune can be used when the motor is loaded and it is not possible to remove the load from the motor shaft. To perform a Stationary autotune, set Pr **00.038** to 1,
2. A rotating autotune should only be used if the motor is unloaded. A rotating autotune first performs a stationary autotune, as above, then a rotating test is performed in which the motor is accelerated with currently selected ramps up to a frequency of *Rated Frequency* (00.039) x 2/3, and the frequency is maintained at that level for 4 seconds. To perform a Rotating autotune, set Pr **00.038** to 2.

RFC-A only:

3. This test measures the total inertia of the load and the motor. A series of progressively larger torque levels are applied to the motor to accelerate the motor up to 3/4 x *Motor Rated Speed* (Pr **00.007**) to determine the inertia from the acceleration/deceleration time.

Following the completion of an autotune test the drive will go into the inhibit state. The drive must be placed into a controlled disable condition before the drive can be made to run at the required reference. The drive can be put in to a controlled disable condition by removing the Safe Torque Off signal from terminals 31 and 35, setting the *Drive Enable* to Off (0) or disabling the drive via the *Control Word* and *Control Word Enable*

	<p>A rotating autotune will cause the motor to accelerate up to 2/3 base speed in the direction selected regardless of the reference provided. Once complete the motor will coast to a stop. The enable signal must be removed before the drive can be made to run at the required reference. The drive can be stopped at any time by removing the run signal or removing the drive enable.</p>
---	---

00.039		Motor Rated Frequency								
RW		Num							US	
OL	⇕	0.00 to 550.00 Hz				⇒	50 Hz: 50.00 Hz 60 Hz: 60.00 Hz			
RFC-A										

Enter the value from the rating plate of the motor. Defines the voltage to frequency ratio applied to the motor.

00.040		Number Of Motor Poles								
RW		Num							US	
OL	⇕	Auto (0) to 32 (16)				⇒	Auto (0)			
RFC-A										

Set to the number of poles of the motor. The auto mode calculates the number of motor poles from the settings of Pr 00.007 and Pr 00.039.

00.041		Control Mode								
RW		Txt							US	
OL	⇕	Ur S (0), Ur (1), Fixed (2), Ur Auto (3), Ur I (4), Square (5), Fixed Tapered (6)				⇒	Ur I (4)			
RFC-A										

Defines the drive output mode, which can either be a voltage mode or a current mode.

Value	Text	Description
0	Ur S	Stator resistance and voltage offset measured at each start
1	Ur	No measurements
2	Fixed	Fixed boost mode.
3	Ur Auto	Stator resistance and voltage offset measured at first drive enable
4	Ur I	Stator resistance and voltage offset measured at each power-up
5	Square	Square law characteristic
6	Fixed Tapered	Fixed boost with taper

NOTE The drive default setting is Ur I mode which means that the drive will carry out an autotune every time the drive is powered-up and enabled. If the load is not going to be stationary when the drive is powered-up and enabled, then one of the other modes should be selected. Not selecting another mode could result in poor motor performance or OI ac, Motor Too Hot or Over Volts trips.

00.042		Low Frequency Voltage Boost								
RW		Num							US	
OL	⇕	0.0 to 25.0 %				⇒	3.0 %			
RFC-A										

Determines the boost level when Pr 00.041 is set to Fixed, Square or Fixed Tapered modes.

00.043		Serial Baud Rate								
RW		Txt							US	
OL	⇕	600 (1), 1200 (2), 2400 (3), 4800 (4), 9600 (5), 19200 (6), 38400 (7), 57600 (8), 76800 (9), 115200 (10)					⇒	19200 (6)		
RFC-A										

Defines the serial baud rate of the drive

Changing the parameters does not immediately change the serial communications settings. See *Reset Serial Communications* (00.045) for more details.

00.044		Serial Address								
RW		Num							US	
OL	⇕	1 to 247					⇒	1		
RFC-A										

Used to define the unique address for the drive for the serial interface. The drive is always a slave address 0 is used to globally address all slaves, and so this address should not be set in this parameter.

Changing the parameters does not immediately change the serial communications settings. See *Reset Serial Communications* (00.045) for more details.

00.045		Reset Serial Communications								
RW		Bit				ND	NC		US	
OL	⇕	Off (0) or On (1)					⇒	Off (0)		
RFC-A										

Set to On (1) to update communications set-up.

NOTE The display will briefly display On and return to Off on reset.

00.046		Brake Controller Upper Current Threshold								
RW		Num							US	
OL	⇕	0 to 200 %					⇒	50 %		
RFC-A										

Defines the upper current threshold for the brake. See Brake Controller Brake Release in *Parameter Reference Guide*.

00.047		Brake Controller Lower Current Threshold								
RW		Num							US	
OL	⇕	0 to 200 %				⇒	10 %			
RFC-A										

Defines the lower current limit for the brake. See Brake Controller Brake Release in *Parameter Reference Guide*.

00.048		Brake Controller Brake Release Frequency								
RW		Num							US	
OL	⇕	0.00 to 20.00 Hz				⇒	1.00 Hz			
RFC-A										

Defines the Brake Release Frequency. See Brake Controller Brake Release in *Parameter Reference Guide*.

00.049		Brake Controller Brake Apply Frequency								
RW		Num							US	
OL	⇕	0.00 to 20.00 Hz				⇒	2.00 Hz			
RFC-A										

Defines the Brake Apply Frequency. See Brake Controller Brake Release in *Parameter Reference Guide*.

00.050		Brake Controller Brake Delay								
RW		Num							US	
OL	⇕	0.0 to 25.0 s				⇒	1.0 s			
RFC-A										

Defines the pre-brake release delay. See Brake Controller Brake Release in *Parameter Reference Guide*.

00.051		Brake Controller Post-brake Release Delay								
RW		Num							US	
OL	⇕	0.0 to 25.0 s				⇒	1.0 s			
RFC-A										

Defines the post-brake release delay.

00.053		Brake Controller Initial Direction								
RW		Txt							US	
OL	⇕	Ref (0), Forward (1), Reverse (2)				⇒	Ref (0)			
RFC-A										

Defines the initial direction of the brake.

Value	Text
0	Ref
1	Forward
2	Reverse

See Brake Controller Brake Release in *Parameter Reference Guide*.

00.054		Brake Controller Brake Apply Through Zero Threshold								
RW		Num							US	
OL	⇕	0.00 to 25.00 Hz				⇒	1.00 Hz			
RFC-A										

Defines if the brake is applied through zero threshold. See Brake Controller Brake Release in *Parameter Reference Guide*.

00.055		Brake Controller Enable								
RW		Txt							US	
OL	⇕	Disable (0), Relay (1), Digital IO (2), User (3)				⇒	Disable (0)			
RFC-A										

Value	Text
0	Disable
1	Relay
2	Digital IO
3	User

If *Brake Controller Enable* (00.055) = Disable, the brake controller is disabled.

If *Brake Controller Enable* (00.055) = Relay, the brake controller is enabled with I/O set up to control the brake via the relay output. Drive ok is re-routed to digital I/O.

If *Brake Controller Enable* (00.055) = Digital I/O, the brake controller is enabled with I/O set up to control the brake via digital I/O. Drive ok is routed to the relay output.

If *Brake Controller Enable* (00.055) = User, the brake controller is enabled, but no parameters are set up to select the brake output.

00.056 to 00.058		Trip 0 to 2							
RO	Txt				ND	NC	PT	PS	
OL	⇕	0 to 255			⇒				
RFC-A									

These parameters show the last 3 trips.

00.059		OUP Enable							
RW	Txt							US	
OL	⇕	Stop (0) or Run (1)			⇒	Run (1)			
RFC-A									

Enables the onboard user program.

Onboard user programming provides a background task that loops continuously and a timed task that is executed each time at a defined rate. For further information refer to the *Control User Guide*.

00.060		OUP Status							
RO	Num				ND	NC	PT		
OL	⇕	-2147483648 to 2147483647			⇒				
RFC-A									

This parameter indicates the status of the user program in the drive. For further information, refer to the *Control User Guide*.

00.065		Frequency Controller Proportional Gain Kp1							
RW	Num							US	
OL	⇕	0.000 to 200.000 s/rad			⇒	0.100 s/rad			
RFC-A									

Defines the proportional gain for frequency controller 1.

RFC modes only.

The controller includes a feed forward proportional gain (Kp), a feed forward integral gain (Ki), and a differential feedback gain (Kd).

Proportional gain (Kp)

If Kp is non-zero and Ki is zero the controller will only have a proportional term, and there must be a frequency error to produce a torque reference. Therefore as the motor load increases there will be a difference between the reference and actual frequencies.

Integral gain (Ki)

The integral gain is provided to prevent frequency regulation. The error is accumulated over a period of time and used to produce the necessary torque reference without any frequency error. Increasing the integral gain reduces the time taken for the frequency to reach the correct level and increases the stiffness of the system, i.e. it reduces the positional displacement produced by applying a load torque to the motor.

00.066		Frequency Controller Integral Gain Ki1								
RW		Num						US		
OL	⇕					⇒				
RFC-A		0.00 to 655.35 s ² /rad					0.10 s ² /rad			

Defines the integral gain for frequency controller 1. See *Frequency Controller Proportional Gain Kp1* (00.065).

00.067		Sensorless Mode Filter								
RW		Txt						US		
OL	⇕					⇒				
RFC-A		4 (0), 5 (1), 6 (2), 8 (3), 12 (4), 20 (5) ms					4 (0) ms			

Defines the time constant for the filter applied to the output of the frequency estimator system.

00.069		Spin Start Boost								
RW		Num						US		
OL	⇕	0.0 to 10.0				⇒	1.0			
RFC-A										

Spin Start Boost (00.069) is used by the algorithm that detects the frequency of a spinning motor when the drive is enabled and *Catch A Spinning Motor* (00.033) ≥ 1 . For smaller motors the default value of 1.0 is suitable, but for larger motors *Spin Start Boost* (00.069) may need to be increased. If *Spin Start Boost* (00.069) is too small the drive will detect zero speed whatever the frequency of the motor, and if *Spin Start Boost* (00.069) is too large the motor may accelerate away from standstill when the drive is enabled.

00.070		PID1 Output								
RO		Num				ND	NC	PT		
OL	⇕	±100.00 %				⇒				
RFC-A										

This parameter is the output of the PID controller. For further information, refer to the *Parameter Reference Guide*.

00.071		PID1 Proportional Gain								
RW		Num						US		
OL	⇕	0.000 to 4.000				⇒	1.000			
RFC-A										

Proportional gain applied to the PID error. For further information, refer to the *Parameter Reference Guide*.

00.072		PID1 Integral Gain								
RW	Num							US		
OL	⇕	0.000 to 4.000				⇒	0.500			
RFC-A										

Integral gain applied to the PID error. For further information, refer to the *Parameter Reference Guide*.

00.073		PID1 Feedback Invert								
RW	Bit							US		
OL	⇕	Off (0) or On (1)				⇒	Off (0)			
RFC-A										

This parameter allows the PID feedback source to be inverted. For further information, refer to the *Parameter Reference Guide*.

00.074		PID1 Output Upper Limit								
RW	Num							US		
OL	⇕	0.00 to 100.00 %				⇒	100.00 %			
RFC-A										

This parameter with *PID1 Output Lower Limit* (Pr **00.075**) allows the output to be limited to a range. For further information, refer to the *Parameter Reference Guide*.

00.075		PID1 Output Lower Limit								
RW	Num							US		
OL	⇕	±100.00 %				⇒	-100.00 %			
RFC-A										

See *PID1 Output Upper Limit* (Pr **00.074**).

00.076		Action On Trip Detection								
RW	Num				ND	NC	PT	US		
OL	⇕	0 - 31				⇒	0			
RFC-A										

Bit 0: Stop on defined non-important trips

Bit 1: Disable braking resistor overload detection

Bit 2: Disable phase loss stop

Bit 3: Disable braking resistor temperature monitoring

Bit 4: Disable parameter freeze on trip. Refer to *Parameter Reference Guide*.

00.077		Maximum Heavy Duty Rating							
RO	Num				ND	NC	PT		
OL	⇕	0.00 to Drive HD Current Rating A			⇒				
RFC-A									

Displays the maximum heavy duty current rating of the drive.

00.078		Software Version							
RO	Num				ND	NC	PT		
OL	⇕	0 to 99.99.99.99			⇒				
RFC-A									

Displays the software version in the drive.

00.079		User Drive Mode							
RW	Txt				ND	NC	PT	US	
OL	⇕	Open loop (1), RFC A (2)			⇒	Open loop (1)			
RFC-A						RFC-A (2)			

Defines the mode of the drive.

00.081		Reference Selected							
RO	Num				ND	NC	PT		
OL	⇕	-Pr 00.002 to Pr 00.002 or Pr 00.001 to Pr 00.002 Hz			⇒				
RFC-A									

This is the basic reference selected from the available sources.

00.082		Pre-ramp Reference							
RO	Num				ND	NC	PT		
OL	⇕	-Pr 00.002 to Pr 00.002 or Pr 00.001 to Pr 00.002 Hz			⇒				
RFC-A									

The *Pre-ramp Reference* is the final output from the reference system that is fed into the ramp system.

00.083		Final Demand Reference							
RO	Num				ND	NC	PT	FI	
OL	⇕	-Pr 00.002 to Pr 00.002 or Pr 00.001 to Pr 00.002 Hz			⇒				
RFC-A									

Open loop mode:

Final Demand Reference shows the fundamental drive output frequency from the *Post Ramp Reference* and the *Hard Frequency Reference*.

RFC mode:

Final Demand Reference shows the reference at the input to the frequency controller, which is the sum of the *Post Ramp Reference*, if the ramp output is not disabled and the hard frequency reference (if enabled). If the drive is disabled *Final Demand Reference* shows 0.00.

00.084		D.C. Bus Voltage							
RO	Num				ND	NC	PT	FI	
OL	⇕	0 to 1190 V			⇒				
RFC-A									

Voltage across the internal DC bus of the drive.

00.085		Output Frequency							
RO	Num				ND	NC	PT	FI	
OL	⇕	± 550.00 Hz			⇒				
RFC-A									

Open loop mode:

The *Output Frequency* is the sum of the *Post Ramp Reference* and the motor slip compensation frequency.

RFC-A mode:

The output frequency is not controlled directly, but the *Output Frequency* is a measurement of the frequency applied to the motor.

00.086		Output Voltage							
RO	Num				ND	NC	PT	FI	
OL	⇕	0 to 930 V			⇒				
RFC-A									

The *Output Voltage* is the rms line to line voltage at the AC terminals of the drive.

00.087		Motor Rpm							
RO	Num				ND	NC	PT	FI	
OL	⇕	±33000.0 rpm			⇒				
RFC-A									

Motor Rpm = 60 x Frequency / Pole pairs

where

Pole pairs = the numeric value of *Number Of Motor Poles* (Pr 00.040) (i.e. 3 for a 6 pole motor)

The frequency used to derive the *Motor Rpm* is the *Final Demand Reference* (Pr 00.083).

00.088		Current Magnitude							
RO	Num				ND	NC	PT	FI	
OL	⇕	0 to Drive Maximum Current A			⇒				
RFC-A									

Current Magnitude is the instantaneous drive output current scaled so that it represents the r.m.s. phase current in Amps under steady state conditions.

00.089		Torque Producing Current							
RO	Num				ND	NC	PT	FI	
OL	⇕	± Drive Maximum Current A			⇒				
RFC-A									

Torque Producing Current is the instantaneous level of torque producing current scaled so that it represents the r.m.s. level of torque producing current under steady state conditions.

00.090		Digital I/O Read Word							
RO	Bin				ND	NC	PT		
OL	⇕	000000000000 to 111111111111			⇒				
RFC-A									

Digital I/O Read Word reflects the state of digital inputs/outputs 1 to 5 and the relay.

00.091		Reference On							
RO	Bit				ND	NC	PT		
OL	⇕	Off (0) or On (1)			⇒				
RFC-A									

Reference On, which is controlled by the drive sequencer, indicates that the reference from the reference system is active.

00.092		Reverse Select							
RO	Bit				ND	NC	PT		
OL	⇕	Off (0) or On (1)			⇒				
RFC-A									

Reverse Select, which is controlled by the drive sequencer, is used to invert *Reference Selected* (Pr **00.081**) or the *Jog Reference* (Pr **00.015**).

00.093		Jog Select							
RO	Bit				ND	NC	PT		
OL	⇕	Off (0) or On (1)			⇒				
RFC-A									

Jog Select, which is controlled by the drive sequencer, is used to select the *Jog Reference* (Pr **00.015**).

00.094		Analog Input 1							
RO	Num				ND	NC	PT	FI	
OL	⇕	±100.00 %			⇒				
RFC-A									

This parameter displays the level of the analog signal present at analog input 1 (terminal 2).



00.095		Analog Input 2							
RO	Num				ND	NC	PT	FI	
OL	⇕	±100.00 %			⇒				
RFC-A									

This parameter displays the level of the analog signal present at analog input 2 (terminal 5).

7 Running the motor

This section takes a new user through all the essential steps to running a motor for the first time.

Table 7-1 Open Loop and RFC-A

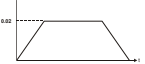
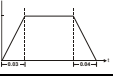
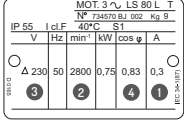
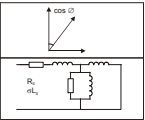
Action	Detail	
Before power up	<p>Ensure:</p> <ul style="list-style-type: none"> The drive enable signal is not given, terminal 31 and 35 is open The run signal is not given, terminal 12/13 is open The motor is connected to the drive The motor connection is correct for the drive Δ or Y The correct supply voltage is connected to the drive 	
Power up the drive	<p>The default setting is Open Loop vector mode. For RFC-A mode set Pr 00.079 to RFC-A, then press the stop/reset button to save the parameters. Ensure: The drive displays: Inhibit (enable terminals are open)</p>	
Enter minimum and maximum speeds	<p>Enter:</p> <ul style="list-style-type: none"> Minimum speed Pr 00.001 (Hz) Maximum speed Pr 00.002 (Hz) 	
Enter accel and decel rates	<p>Enter:</p> <ul style="list-style-type: none"> Acceleration rate Pr 00.003 (s/100 Hz) Deceleration rate Pr 00.004 (s/100 Hz) 	
Enter motor nameplate details	<ol style="list-style-type: none"> Motor rated current in Pr 00.006 (Amps) Motor rated speed in Pr 00.007 (rpm / min⁻¹) Motor rated voltage in Pr 00.008 (Volts) Motor rated power factor in (cos ϕ) Pr 00.009 	
Ready to autotune		
Autotune	<p>The drive is able to perform either a stationary or a rotating autotune. The motor must be at a standstill before an autotune is enabled.</p> <p>To perform an autotune:</p> <ul style="list-style-type: none"> Set Pr 00.038 = 1 for a stationary autotune or set Pr 00.038 = 2 for a rotating autotune Close the drive enable signal (apply +24 V to terminal 31 & 35). The drive will display 'Ready'. Give a Run command (apply +24 V to terminal 12 - Run forward or terminal 13 - Run reverse). The lower display will flash 'Auto Tune' while the drive is performing the autotune. Wait for the drive to display 'Inhibit' and for the motor to come to a standstill. Remove the drive enable and run signal from the drive. 	
Autotune complete	When the autotune has been completed, Pr 00.038 will be set to 0	
Tuning of frequency controller gains (RFC-A mode only)	Depending on the application, the frequency controller gains (Pr 00.065 and Pr 00.066) may need to be adjusted.	
Save parameters		
Save parameters	Select 'Save Parameters' in Pr mm.000 (alternatively enter a value of 1001) and press the Stop / Reset button to save parameters.	

Ready to run		
Run	The drive is now ready to run the motor. Close the Run Forward or Run Reverse terminals.	
Increasing and decreasing speed	Changing the selected analog frequency reference will increase and decrease the speed of the motor.	
Stopping	To stop the motor by following the selected deceleration rate, open either the run forward or run reverse terminal. If the enable terminal is opened while the motor is running, the drive output is immediately disabled and the motor will coast to a stop.	

8 Diagnostics



Users must not attempt to repair a drive if it is faulty, nor carry out fault diagnosis other than through the use of the diagnostic features described in this chapter.
If a drive is faulty, it must be returned to the supplier of the drive for repair.

Table 8-1 Trip indication

Trip code	Condition	Description
An Input 1 Loss	Analog input 1 current loss	Current loss was detected in current mode on Analog input 1 (Terminal 2).
An Input 1 OI	Analog input 1 over-current	Current input on analog input 1 exceeds 24 mA.
An Input 2 Loss	Analog input 2 current loss	Current loss was detected in current mode on Analog input 2 (Terminal 5).
An Input 2 OI	Analog input 2 over-current	Current input on analog input 2 exceeds 24 mA.
Autotune	Measured inertia has exceeded the parameter range	The drive has tripped during a rotating autotune or mechanical load measurement test.
Autotune Stopped	Autotune test stopped before completion	The drive was prevented from completing an autotune test, because either the drive enable or the drive run signals were removed.
Brake R Too Hot	Braking resistor overload timed out (I ² t)	Braking resistor overload has timed out.
Card Access	NV Media Card Write fail	Unable to access the NV Media Card.
Card Boot	The Menu 0 parameter modification cannot be saved to the NV Media Card	The necessary boot file has not been created on the NV media card fitted to the drive to take the new parameter value. This occurs when <i>Parameter Cloning</i> (00.030) is changed to auto or boot mode, but the drive is not subsequently reset.
Card Busy	NV Media Card cannot be accessed as it is being accessed by an option module	The <i>Card Busy</i> trip indicates that an attempt has been made to access a file on NV Media Card, but the NV Media Card is already being accessed by an option module. No data is transferred.
Card Compare	NV Media Card file/data is different to the one in the drive	Trip is initiated if the parameters on the NV Media Card are different to the drive.
Card Data Exists	NV Media Card data location already contains data	Attempt has been made to store data on a NV Media Card in a data block which already contains data.
Card Drive Mode	NV Media Card parameter set not compatible with current drive mode	The drive mode in the data block on the NV Media Card is different from the current drive mode.
Card Error	NV Media Card data structure error	Attempt has been made to access the NV Media Card but an error has been detected in the data structure on the card. Resetting the trip will cause the drive to erase and create the correct folder structure.
Card Full	NV Media Card full	There is not enough space left on the card.
Card No Data	NV Media Card data not found	Attempt has been made to access non-existent file or block on the NV Media Card.
Card Option	NV Media Card trip; option modules installed are different between source drive and destination drive	The <i>Card Option</i> trip indicates that parameter data or default difference data is being transferred from the NV Media Card to the drive, but the option module category is different between the source and destination drives.
Card Product	NV Media Card data blocks are not compatible with the drive derivative	If Drive Derivative is different between the source and target drives. Refer to the <i>Control User Guide</i> .

Trip code	Condition	Description				
Card Rating	NV Media Card Trip; The voltage and / or current rating of the source and destination drives are different	The current and / or voltage ratings are different between source and destination drives.				
Card Read Only	NV Media Card has the Read Only bit set	Attempt has been made to modify a read-only NV Media Card or a read-only data block.				
Card Slot	NV Media Card trip; Option module file transfer has failed	The Card Slot trip is initiated, if the transfer of an option module file to or from a module failed because the option module does not respond correctly.				
Control Word	Trip initiated from the <i>Control Word</i>	Initiated by setting bit 12 on the control word when the control word is enabled. Refer to the <i>Parameter Reference Guide</i> .				
Current Offset	Current feedback offset error	Current offset is too large to be trimmed.				
Data Changing	Drive parameters are being changed	A user action or a file system write is active that is changing the drive parameters and the drive has been commanded to enable.				
Derivative ID	Derivative file error	Contact the supplier of the drive.				
Derivative Image	Derivative product image error	Contact the supplier of the drive				
Destination	Two or more parameters are writing to the same destination parameter	The <i>dest</i> trip indicates that destination output parameters of two or more logic functions (Menus 7 and 8) within the drive are writing to the same parameter.				
Drive Config	Drive configuration	Contact the supplier of the drive.				
EEPROM Fail	Default parameters have been loaded	<p>The cause of the trip can be identified from the sub trip number displayed after the trip string.</p> <table border="1"> <thead> <tr> <th>Sub-trip</th> <th>Reason</th> </tr> </thead> <tbody> <tr> <td>1</td> <td><i>External Trip = 1</i></td> </tr> </tbody> </table> <p>Refer to the <i>Control User Guide</i>.</p>	Sub-trip	Reason	1	<i>External Trip = 1</i>
Sub-trip	Reason					
1	<i>External Trip = 1</i>					
External Trip	External trip is initiated	<p>The cause of the trip can be identified from the sub trip number displayed after the trip string.</p> <table border="1"> <thead> <tr> <th>Sub-trip</th> <th>Reason</th> </tr> </thead> <tbody> <tr> <td>1</td> <td><i>External Trip = 1</i></td> </tr> </tbody> </table> <p>Refer to the <i>Control User Guide</i>.</p>	Sub-trip	Reason	1	<i>External Trip = 1</i>
Sub-trip	Reason					
1	<i>External Trip = 1</i>					
Fan Fail	Fan fail	Indicates the fan or fan circuitry has failed				
File Changed	File changed	A file has been changed, power cycle to clear the trip				
FW Incompatible	Firmware Incompatibility	The user firmware is incompatible with the power firmware.				
HFxx trip	Hardware faults	Internal drive hardware fault (see the <i>Control User Guide</i>).				
Hot Rect/Brake	Hot rectifier/brake	Over-temperature detected on input rectifier or braking IGBT.				
I cal. range	Current calibration range	Current calibration range error.				
I/O Overload	Digital output overload	The total current drawn from the AI-Adaptor 24 V supply or from the digital output has exceeded the limit.				
Keypad Mode	Keypad has been removed when the drive is receiving the reference from the keypad	The <i>Keypad Mode</i> trip indicates that the drive is in keypad mode [<i>Reference Selector = 4 or 6</i>] and the keypad has been removed or disconnected from the drive. Refer to the <i>Control User Guide</i> .				

Trip code	Condition	Description
Motor Too Hot	Output current overload timed out (I^2t)	trip indicates a motor thermal overload based on the output current and motor thermal time constant. The drive will trip on <i>Motor Too Hot</i> when the accumulator gets to 100 %. This can occur when: <ul style="list-style-type: none"> • There is excessive mechanical load • Ensure the load is not jammed / sticking • Check the load on the motor has not changed • Ensure the motor rated current is not zero
No power board	No power board	No communication between the power and control boards.
OHot Brake	Braking IGBT over-temperature	Braking IGBT over-temperature
OHot Control	Control stage over-temperature	Control stage over-temperature
OHot dc bus	DC bus over temperature	DC bus component over temperature based on a software thermal model.
OHot Inverter	Inverter over temperature based on thermal model	IGBT junction over-temperature has been detected based on a software thermal model.
OHot Power	Power stage over temperature	This trip indicates that a power stage over-temperature has been detected.
OHot Rectifier	Rectifier over temperature	The <i>OHot Rectifier</i> trip indicates that a rectifier over-temperature has been detected.
OI ac	Instantaneous output over current detected	The instantaneous drive output current has exceeded the set limit. Possible solutions: <ul style="list-style-type: none"> • Increase acceleration/deceleration rate • If seen during autotune reduce the voltage boost • Check for short circuit on the output cabling • Check integrity of the motor insulation using an insulation tester • Is the motor cable length within limits for the frame size • Reduce the values in the current loop gain parameters
OI Brake	Braking IGBT over current detected: short circuit protection for the braking IGBT activated	Over current has been detected in braking IGBT or braking IGBT protection has been activated. Possible cause: <ul style="list-style-type: none"> • Check brake resistor wiring • Check braking resistor value is greater than or equal to the minimum resistance value • Check braking resistor insulation
Option Disable	Option module does not acknowledge during drive mode changeover	Option module did not acknowledge notifying the drive that communications with the drive has been stopped during the drive mode changeover within the allocated time.
Out Phase Loss	Output phase loss detected	Phase loss has been detected at the drive output.
Output phase s/c	Output phase short-circuit	Over-current detected on drive output when enabled.
Over Speed	Motor frequency has exceeded the over frequency threshold	Excessive motor speed (typically caused by mechanical load driving the motor).

Trip code	Condition	Description
Over Volts	DC bus voltage has exceeded the peak level or maximum continuous level for 15 seconds	The <i>Over Volts</i> trip indicates that the DC bus voltage has exceeded the maximum limit. Possible solutions: <ul style="list-style-type: none"> • Increase <i>Deceleration Rate 1</i> (Pr 00.004) • Decrease the braking resistor value (staying above the minimum value). • Check nominal AC supply level. • Check for supply disturbances which could cause the DC bus to rise. • Check motor insulation using a insulation tester.
Phase Loss	Supply phase loss	The drive has detected an input phase loss or large supply imbalance.
Power Board HF	Power board HF	Power processor hardware fault.
Power Comms	Communication has been lost / errors detected between power and control	No communications between power and control.
Power Data	Power system configuration data error	Error in the configuration data stored in the power system.
Power Down Save	Power down save error	Error has been detected in the power down save parameters saved in non-volatile memory.
PSU	Internal power supply fault	One or more internal power supply rails are outside limits or overloaded.
Resistance	Measured resistance has exceeded the parameter range	The measured stator resistance during an autotune test has exceeded the maximum possible value of <i>Stator Resistance</i> . Refer to the <i>Control User Guide</i> .
Slot 1 Different	Option module in option slot 1 has changed	Option module in option slot 1 on the drive is a different type to that installed when parameters were last saved on the drive.
Slot 1 Error	Option module in option slot 1 has detected a fault	Option module in option slot 1 on the drive has detected an error.
Slot 1 HF	Option module 1 hardware fault	Option module in option slot 1 on the drive has indicated a hardware fault.
Slot 1 Not Fitted	Option module in option slot 1 has been removed	Option module in option slot 1 on the drive has been removed since the last power up.
Slot 1 Watchdog	Option module watchdog function service error	Option module installed in Slot 1 has started the option watchdog function and then failed to service the watchdog correctly.
Soft Start	Soft start relay failed to close, soft start monitor failed	Soft start relay in the drive failed to close or the soft start monitoring circuit has failed.
STO Error	No Safe Torque Off board installed	STO board not installed.
Stored HF	Hardware trip has occurred during last power down	Hardware trip (HF01 –HF19) has occurred and the drive has been power cycled. Enter 1299 to xx.000 to clear trip
Sub-array RAM	RAM allocation error	The <i>Sub-array RAM</i> trip indicates that an option module derivative image has requested more parameter RAM than is allowed.
Temp Feedback	Internal thermistor has failed	Internal thermistor has failed.
Th Brake Res	Brake resistor over temperature	The <i>Th Brake Res</i> trip is initiated if the hardware based braking resistor thermal monitoring is connected and the resistor overheats.
Th Short Circuit	Motor thermistor short circuit	The <i>Th Short Circuit</i> trip indicates that the motor thermistor connected to terminal 14 (digital input 5) on the control connections, is short circuit or low impedance (<50 Ω).

Trip code	Condition	Description
Thermistor	Motor thermistor over-temperature	The <i>Thermistor</i> trip indicates that the motor thermistor connected to terminal 14 (digital input 5) on the control connections has indicated a motor over temperature.
User OI ac	User OI ac	The <i>User OI ac</i> trip is initiated if the output current of the drive exceeds the trip level set by <i>User Over Current Trip Level</i> . Refer to the <i>Control User Guide</i> .
User Prog Trip	Trip generated by an onboard user program	This trip can be initiated from within an onboard user program
User Program	On board user program error	An error has been detected in the onboard user program image.
User Save	User Save error / not completed	The <i>User Save</i> trip indicates that an error has been detected in the user save parameters saved in non-volatile memory.
Watchdog	Control word watchdog has timed out	The <i>Watchdog</i> trip indicates that the control word has been enabled and has timed out

8.1 Alarm indications

In any mode, an alarm is an indication given on the display by alternating the alarm string with the drive status string display. If an action is not taken to eliminate any alarm except "Auto Tune, Limit Switch or 24V Backup Lost" the drive may eventually trip. Alarms are not displayed when a parameter is being edited.

Table 8-2 Alarm indications

Alarm string	Description
Brake Resistor	Brake resistor overload. <i>Braking Resistor Thermal Accumulator</i> in the drive has reached 75.0 % of the value at which the drive will trip. Refer to the <i>Power Installation Guide</i> .
Motor Overload	<i>Motor Protection Accumulator</i> in the drive has reached 75.0 % of the value at which the drive will trip and the load on the drive is >100 %, reduce motor current (load). Refer to the <i>Parameter Reference Guide</i> .
Drive Overload	Drive over temperature. <i>Percentage Of Drive Thermal Trip Level</i> in the drive is greater than 90 %. Refer to the <i>Parameter Reference Guide</i> .
Auto Tune	The autotune procedure has been initialized and an autotune in progress.
Limit Switch	Limit switch active. Indicates that a limit switch is active and that is causing the motor to be stopped.
Low AC	Low voltage mode. See <i>Low AC Alarm</i> in the <i>Control User Guide</i> .
Current limit	Current limit active. See <i>Current Limit Active</i> in the <i>Control User Guide</i> .
24V Backup Lost	24V backup not present. See <i>24V Alarm Loss Enable</i> in the <i>Control User Guide</i> .

9 NV Media Card Operation

Figure 9-1 Installing the AI-Backup adaptor (SD Card)

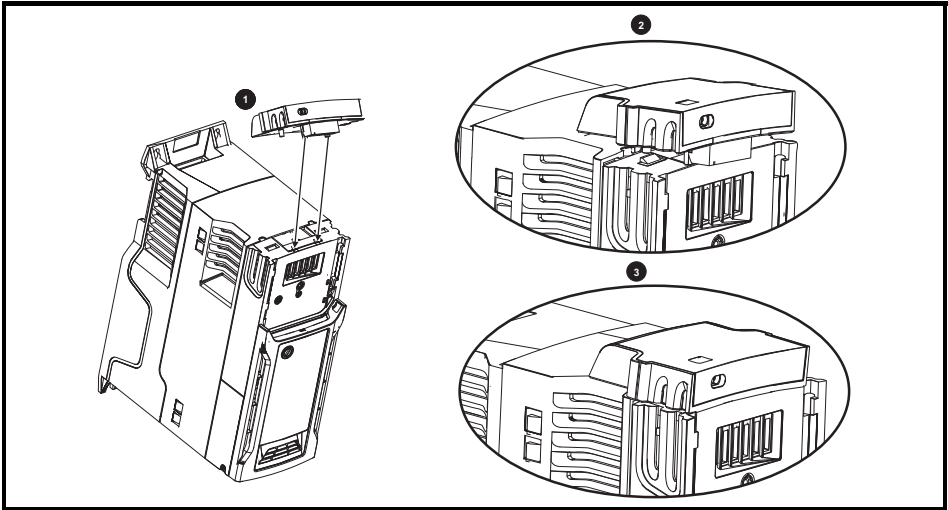

1. Identify the two plastic fingers on the underside of the AI-Backup adaptor (1) - then insert the two fingers into the corresponding slots in the spring-loaded sliding cover on the top of the drive.
2. Hold the adaptor firmly and push the spring loaded protective cover towards the back of the drive to expose the connector block (2) below.

Press the adaptor downwards (3) until the adaptor connector locates into the drive connection below.

Figure 9-2 Basic NV Media Card operation

<p>Drive reads all parameters from the NV Media Card</p>	<p>Programs all drive parameters to the NV Media Card</p> <p>NOTE Overwrites any data already in data block 1</p>
<p>Pr 00.030 = Read + </p>	<p>Pr 00.030 = Program + </p>
<p>Drive automatically writes to the Media Card when a parameter save is performed</p>	<p>Drive boots from the NV Media Card on power up and automatically writes to the Media Card when a parameter save is performed</p>
<p>Pr 00.030 = Auto + </p>	<p>Pr 00.030 = Boot + </p>

The whole card may be protected from writing or erasing by setting the read-only flag, refer to the *Control User Guide* for further information. The card should not be removed during data transfer, as the drive will produce a trip. If this occurs then either the transfer should be reattempted or in the case of a card to drive transfer, default parameters should be loaded.

NOTE The drive supports SD cards formatted with the FAT32 file system only.

10 Machine Control Studio

Machine Control Studio programming software powered by CODESYS

Machine Control Studio software provides a flexible and intuitive environment for programming Unidrive M's new automation and motion control features. This new software offers programming for the Unidrive M400's onboard PLC.

Machine Control Studio is powered by CODESYS, the leading open software for programmable machine control. The programming environment is fully EN/IEC 61131-3 compliant, meaning that it is familiar and therefore fast and easy to use for control engineers around the world.

The following EN/IEC 61131-3 programming languages are supported:

- Structured Text (ST)
- Function Block Diagram (FBD)
- Structured Function Chart (SFC)
- Ladder Diagram (LD)
- Instruction List (IL)

Also supported:

- Continuous Function Chart (CFC)

Onboard intelligence

- Programmable Logic Control (PLC) - memory: 12 kB
- 1 x Real-time task (16 ms), 1 x Background task

Intuitive IntelliSense functionality helps to write consistent and robust programming, speeding up software development. Programmers have access to a vibrant open-source community for function blocks. Machine Control Studio supports customers' own function block libraries, with on-line monitoring of program variables with user defined watch windows and help for on-line change of program, in line with current PLC practices.

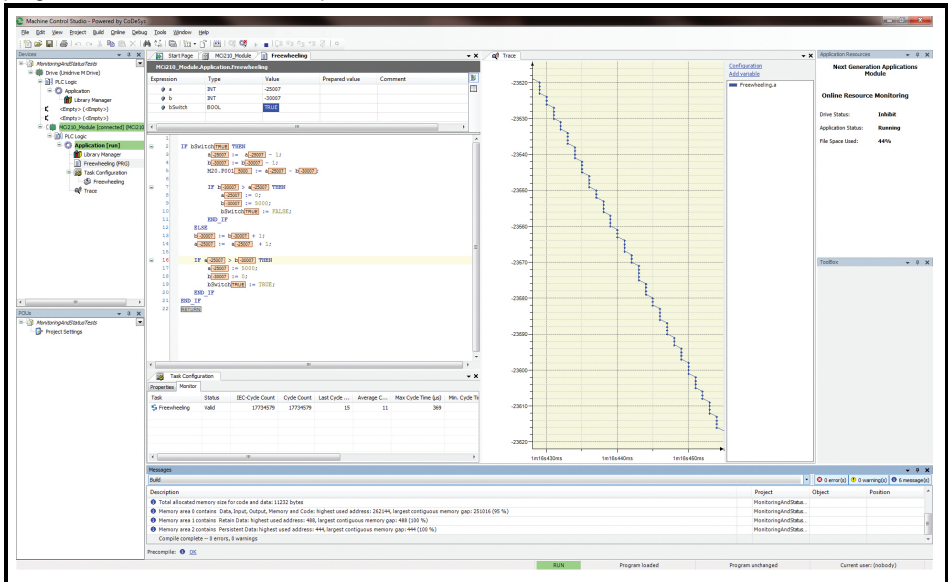

Download Machine Control Studio from: www.drive-setup.com.

11 Default control connections

Figure 11-1 Frame 1 to 4 connections

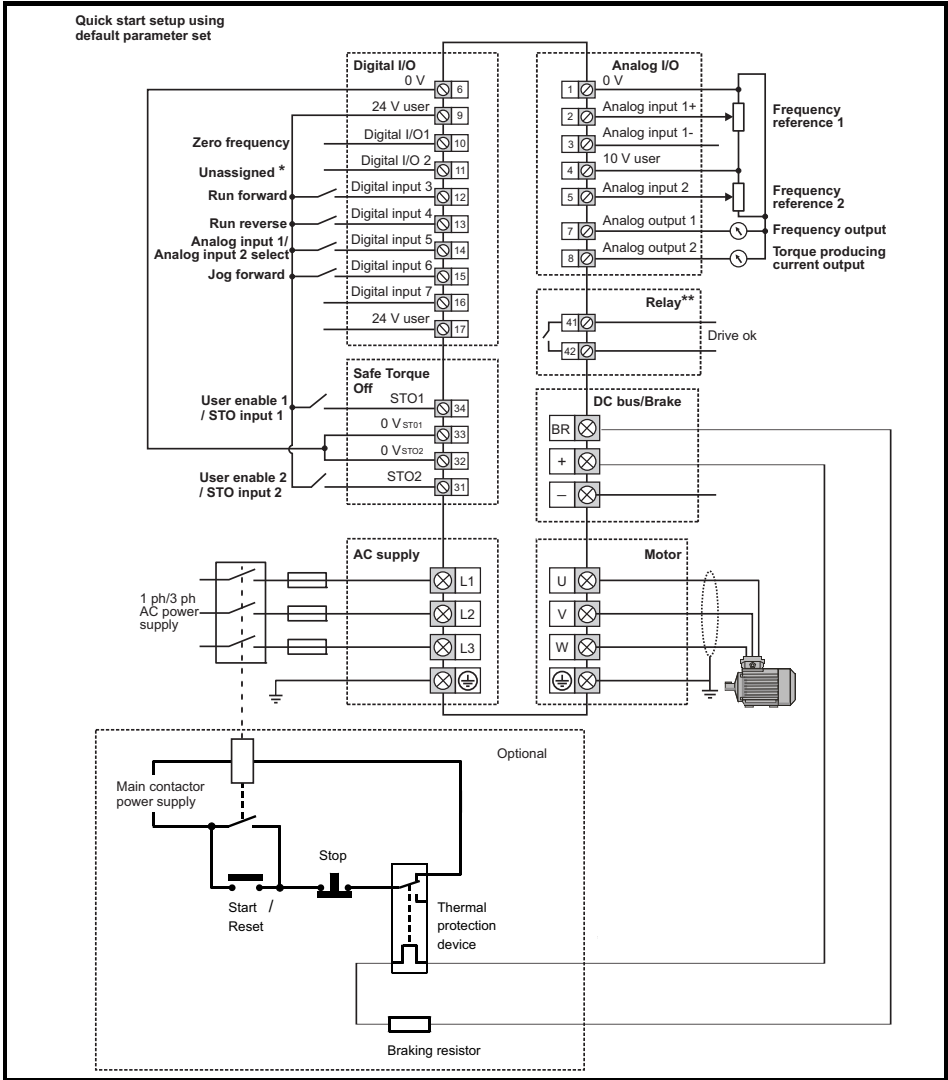

* Unidrive M400 uses Safe Torque Off (drive enable) inputs and terminal 11 is unassigned.

** 250 Vac maximum (UL class 1).

NOTE The 0 V terminals on the Safe Torque Off are isolated from each other and the 0 V common.
On the size 2 110 V drives or when connecting single phase to a dual rated 200 V unit, the supply should be connected to L1 and L3.

NOTE For Frame 5 and above default control connections, see the back cover of this guide.

Figure 11-2 Frame 5 and above default control connections

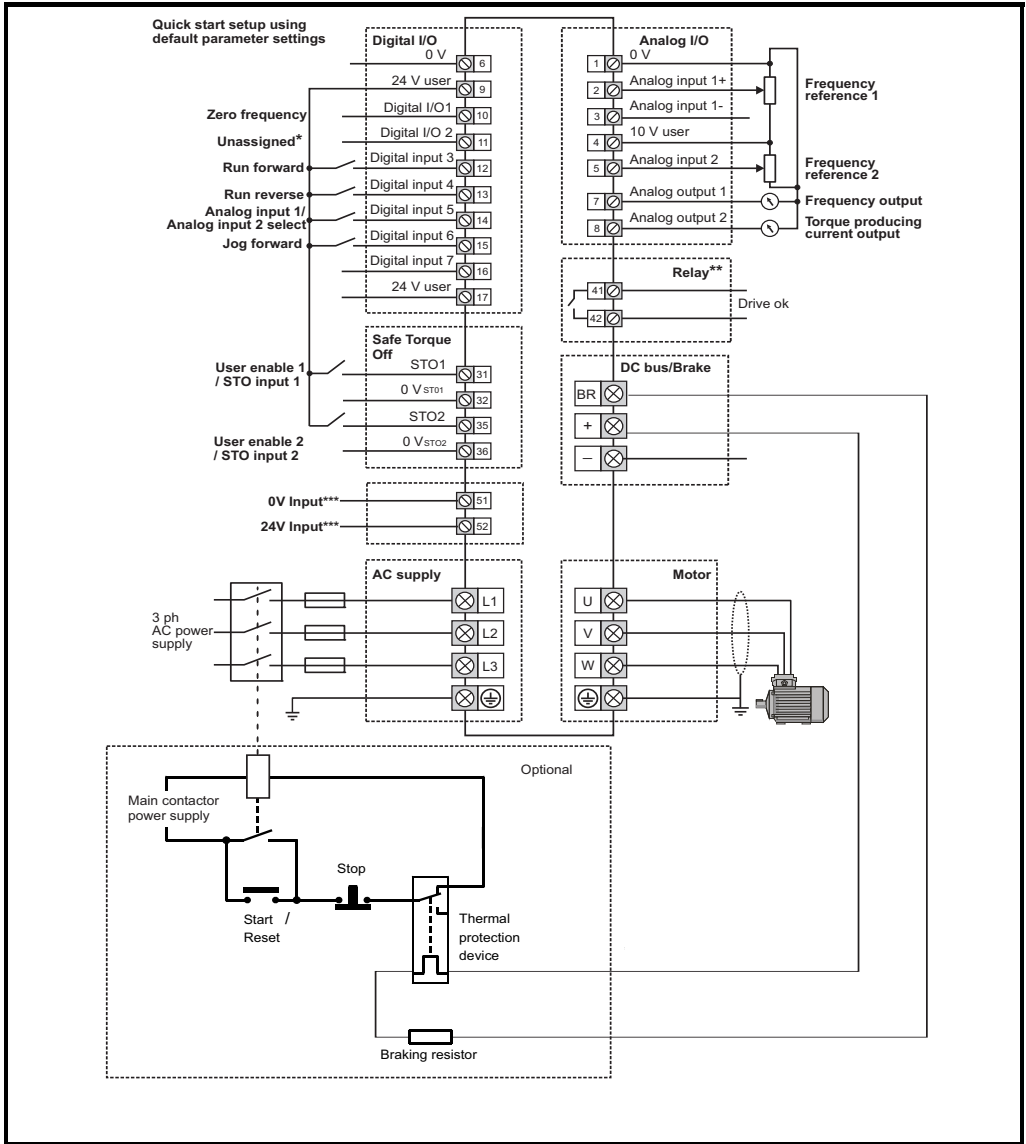

* Unidrive M400 uses Safe Torque Off (drive enable) inputs and terminal 11 is unassigned.

** 250 Vac maximum (UL class 1).

*** Size 6 and larger only.

NOTE The 0 V terminals on the Safe Torque Off are not isolated from each other and the 0 V common.



0478-0267-04