

# CONTROL TECHNIQUES



# DIGITAX HD

MINIMUM SIZE, MAXIMUM PERFORMANCE  
SERVO DRIVES

**DRIVE OBSESSED**

# CONTENTS

DIGITAX HD OVERVIEW	3
INTEGRATED SAFETY	8
INSTALLATION & COMMISSIONING	10
DRIVE VARIANTS	13
MOTION CONTROL	22
UNIMOTOR HD OVERVIEW	24
ENERGY EFFICIENCY	26
TECHNICAL SPECIFICATION	28
MOTOR - DRIVE COMBINATIONS	32
MULTI-AXIS CONFIGURATIONS	36
ORDERING GUIDE	38
KITS & ACCESSORIES	42
DRIVE RATINGS & DIMENSIONS	46
MOTOR RATINGS & DIMENSIONS	50
COMPANY INFORMATION	62



# SERVO SOLUTIONS FOR CONTINUOUS & PULSE DUTY APPLICATIONS

Receive the ultimate in performance and flexibility for machinery manufacturers with a broad range of servo drives and motors.



## Digitax HD

Bring superior performance to high dynamic, pulse duty applications, where high peak torque is essential for fast acceleration with the Digitax HD range.

### Digitax HD

0.25 kW - 7.5 kW  
(0.6 hp - 9.8 hp)  
200 V | 400 V

### Unidrive M700

0.75 kW - 2.8 MW  
(1 hp - 4,200 hp)  
200 V | 400 V | 575 V | 690 V

## Unidrive M700

Providing optimum performance and an extensive power range - M700 is the ideal option for continuous duty applications that need precise continuous torque delivery.

300% Overload

200% Overload

## Unimotor

Unimotor is a comprehensive family of high-performance AC brushless servo motors. With a wide torque and speed range and a broad selection of feedback options, Unimotor offers the perfect match for Digitax HD and Unidrive M700 to meet any application requirement.



Pulse Duty Servo Range - Unimotor HD  
(Optimised with the Control Techniques pulse duty drive)

# MINIMUM SIZE SERVO SOLUTIONS

1.5 A – 16 A with 48 A peak

200 V | 400 V

## Downsize cost and upsize floor space

With a tiny footprint but exceptional power density, Digitax HD is one of the smallest servo drives on the market today. Build the most compact cabinets possible.

## The market's narrowest servo drive

- Digitax HD is just 40mm (1.6 in) wide
- 25 drives, up to 16A per drive, can fit in just 1 meter (40 in) of cabinet space



40mm (1.6 in)

Typical competitors



Install a Digitax HD in a 200 mm deep cabinet

## Drive dimensions

Frame size	Dimensions H x W x D mm (in)	Weight kg (lb)	Nominal current @ 400V	Peak current @ 400V
1	233 x 40 x 174 (9.17 x 1.57 x 6.85)	0.75 (1.65)	4.2 A	12.6 A
2	278 x 40 x 174 (11.0 x 1.57 x 6.85)	1.3 (3.0)	10.5 A	31.5 A
3	328 x 40 x 174 (12.9 x 1.57 x 6.85)	1.5 (3.3)	12.9 A	48 A

Actual size



Just 40 mm (1.6 in)

# ULTRAFLOW™ THERMAL MANAGEMENT

# KEEP CABINET

# SIZES COMPACT

## Heat management

Create shorter cabinets by directly stacking rows of drives. Control Techniques' unique Ultraflow™ technology expels heat directly outside the cabinet through the rear of the drive\* and stops heat building up in the cabinet.

## No Contamination

Ultraflow™'s guided internal airflow prevents ingress on drive circuits and, combined with conformal coating, minimises contamination risk.

## Smart fan control

An intelligently controlled fan means fans last longer and create less acoustic noise while contributing to the maximum thermal cooling by Ultraflow™.

## Easy installation

Ultraflow™ requires only a 32 mm (1.25 in) hole in the cabinet meaning rapid, trouble-free installation\*\*

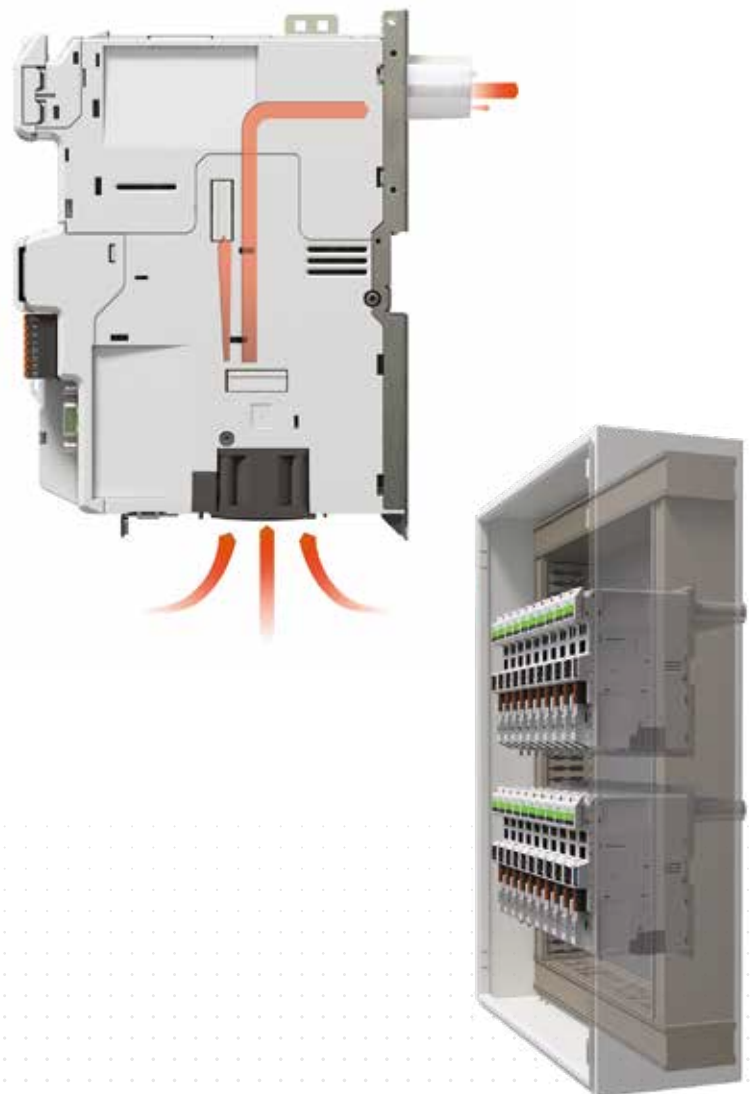

Ultraflow™ is a registered Trademark of Control Techniques

\* Drive heat dissipation can also be achieved via vents on top of the drive, as standard.

\*\* Frames 2 and 3 require 2 x 32mm (1.5 in) holes

# MAXIMUM PERFORMANCE SERVO SOLUTIONS

## Boost throughput with maximum control

**Get the best throughput and production quality in your machines by using Digitax HD, the perfect drive for high-dynamic applications.**

- 300% peak current performance
- Optimised control loops for high dynamic performance
  - i. 62.5  $\mu$ s current loop
  - ii. 250  $\mu$ s position and speed loop
- Unique 'dead beat' current controller for maximum bandwidth
- Up to 16 kHz switching frequency (default ratings specified at 8 kHz)
- Advanced bi-quad filters for suppression of mechanical resonances

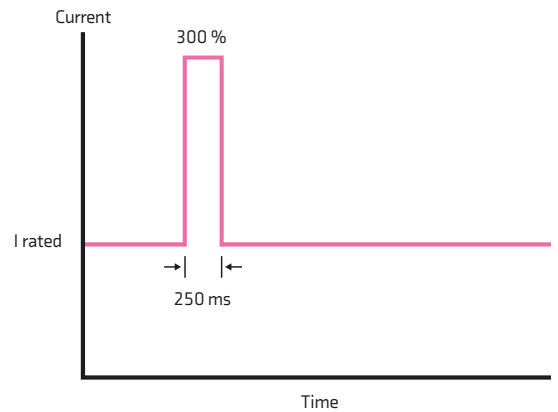

## Improving accuracy through precision encoder feedback

**The flexible speed and position feedback interface supports a wide range of feedback technologies, from robust resolvers to high resolution encoders:**

- Up to three onboard encoder channels simultaneously e.g. 1 feedback encoder, 1 reference encoder and 1 simulated output
- Quadrature, AB Servo, SinCos (including absolute), SSI, BiSS, EnDat 2.1/2.2, Hiperface and resolvers
- Simulated encoder output can provide position reference for cams, digital lock and electronic gearbox
- Up to 25 bit encoder resolution on Unimotor HD
- Feedback accuracy as low as  $\pm 20$  arcsec on Unimotor HD

# FROM STANDALONE...

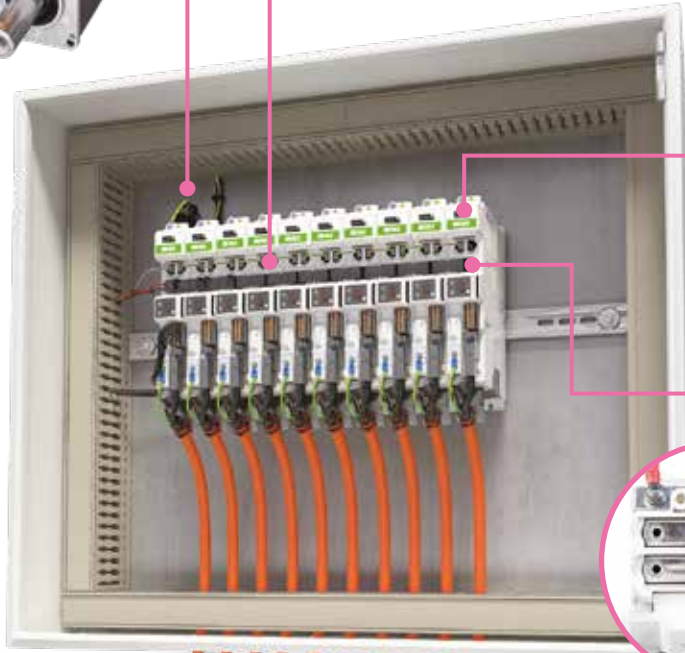

Single AC Input

Communication links

Common DC bus and earth

24 Vdc links

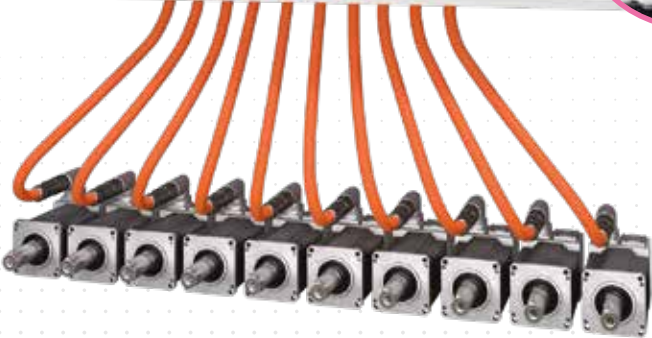

# ...TO A MODULAR COMMON DC BUS SYSTEM

# THE NEW PARADIGM OF SYSTEM DESIGN

# INTEGRATED

# SAFETY

**Modern industrial processes face a three-fold challenge: the constant demand for increased machine throughput, matched by a parallel need to reduce complexity and points of failure, all the while ensuring the health and safety of human operators and allowing them interaction with the running process.**

Modernising system design, replacing traditional electro-mechanical safety components with the capabilities of the latest generation of variable speed drives, is the new standard across industries to increase efficiency and availability.

Digitax HD offers integrated dual Safe Torque Off (STO) inputs, certified to SIL3 / PLe, providing an elegant and more reliable solution over traditional motor contactors.







## Enhanced, decentralised motion safety with the MiS250

The MiS250 safety option for Digitax HD extends the built-in STO with the ability to safely monitor and/or restrict the scope of motion. The use of drive-based safe motion provides faster reaction times while also reducing the demand upon - and therefore the cost of - the central safety PLC.

Wiring complexity is dramatically reduced, as the MiS250 can use the same encoder feedback already connected to the drive. Taking advantage of the Safe EnDat protocol, the MiS250 achieves up to SIL3 / PLe with a single encoder.

The MiS250 has been designed to meet the following standards:

- IEC 61508 SIL3
- IEC 62061
- ISO 13849-1 PLe
- IEC 61800-5-2
- European Machinery Directive 2006/42/EC

MiS250 adds the following motion safety functions to Digitax HD:

- Safe Stop 1 (SS1)
- Safe Stop 2 (SS2)
- Safely Limited Speed (SLS)
- Safe Operating Stop (SOS)
- Safe Direction (SDI)
- Safe Speed Monitor (SSM)
- Safe Emergency Stop (SES)
- Safely Limited Position (SLP)
- Safely Limited Acceleration (SLA)
- Safe Brake Control (SBC)
- Two Hand Control

Additionally, these motion safety functions can be controlled over the following safe networks:

- Safety over Ethernet with CIP Safety
- Fail Safe over EtherCAT, FSoE



# MINIMUM EFFORT RAPID INSTALLATION

Our innovative design means you only increase drive size when option modules are used. That means you can save oodles of space in the overall configuration.

The multi-axis paralleling kit includes busbars for quick connection of DC bus and earth link, as well as Quick Links to distribute 24 Vdc supply across drives:

- Reduces installation time and cost
- Improves energy efficiency and footprint

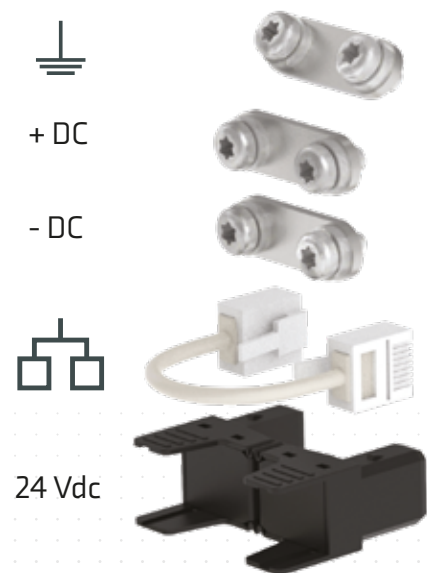

The LED display ensures access to drive diagnostics even in the absence of network connectivity.

Includes 2 rotary switches for hardware setting of the node address for faster commissioning of the motion network.

The motor power connector is in the same position for all frame sizes, making cable routing easier and tidier.

- Easy access pluggable connectors

AC input

DC bus cover

Communication ports

24 Vdc Input

I/O

Dual Safe Torque Off (STO)

Motor earth

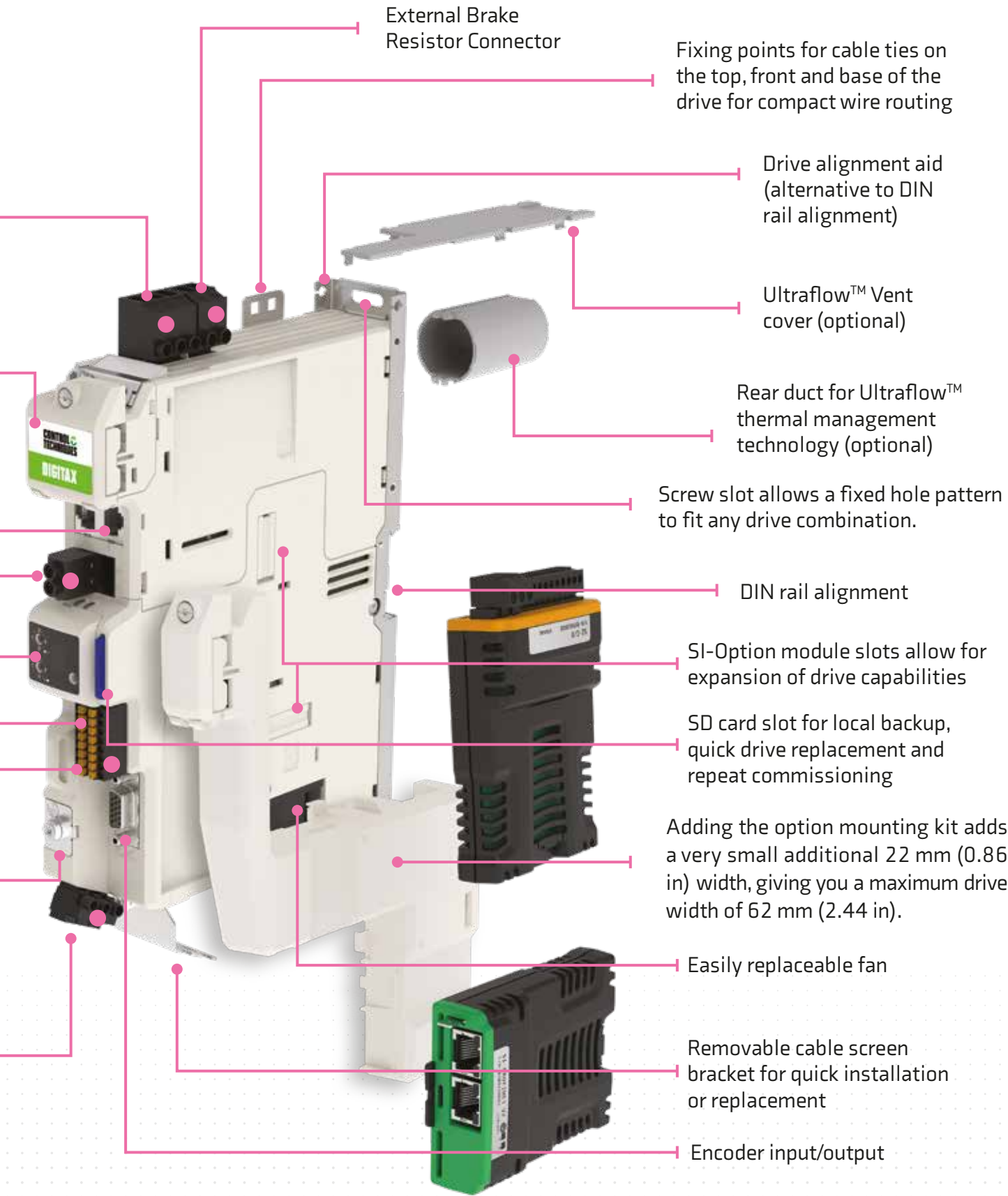

External Brake Resistor Connector

Fixing points for cable ties on the top, front and base of the drive for compact wire routing

Drive alignment aid (alternative to DIN rail alignment)

Ultraflow™ Vent cover (optional)

Rear duct for Ultraflow™ thermal management technology (optional)

Screw slot allows a fixed hole pattern to fit any drive combination.

DIN rail alignment

SI-Option module slots allow for expansion of drive capabilities

SD card slot for local backup, quick drive replacement and repeat commissioning

Adding the option mounting kit adds a very small additional 22 mm (0.86 in) width, giving you a maximum drive width of 62 mm (2.44 in).

Easily replaceable fan

Removable cable screen bracket for quick installation or replacement

Encoder input/output

# RAPID COMMISSIONING

## Connect

The Connect PC tool is for rapid commissioning, plus optimising and monitoring drive/system performance:

- Task-based drive operations are simplified with intuitive graphical tools in a familiar Windows environment
- CTScope – a realtime software oscilloscope – facilitates tuning and monitoring
- Dynamic logic diagrams and searchable parameter listings
- Tool is scalable, through optional add-ins, to match application requirements
- Multiple communications channels for a more complete overview of the system
- Drive discovery gives the ability to find drives on a network automatically without the user having to specify their addresses
- Offline configuration



## SD card

Standard SD cards can be used for quick and easy parameter and program storage.

## Remote mountable keypad\*

Flexible mounting on the outside of a panel, for quick changes to drive parameters or reading diagnostics.



## Plug-and-play motor connection

Automatic electronic motor nameplate identification for fast setup

\*requires KI-Compact 485 adaptor to connect keypad to Drive



### Drive set-up

Quickly find everything you need for quick and easy installation of your drives.

Visit: [www.drive-setup.com](http://www.drive-setup.com)



### Diagnostic Tool

Quickly solve any error codes that the drive may show. You can download our Diagnostics Tool app at:

[controltechniques.com/mobile-applications](http://controltechniques.com/mobile-applications)



\*For Microsoft users, please note that this mobile app operates with Windows 10 only.

# APPLICATION FLEXIBILITY

# THE RIGHT VARIANT GUARANTEED



## M750 ETHERNET

The multi-protocol drive that does it all



## M753 ETHERCAT

For high-performance centralised motion control architecture



## M754 MCI

Servo drive and controller in one



## M751 BASE

Configuration flexibility with option modules



# M750 ETHERNET

Multi-protocol network drive for centralised and decentralised motion applications

## Digitax M750 Ethernet

- Onboard multi-protocol Ethernet, supporting Real Time Motion over Ethernet (RTMoE), EtherNet/IP, Modbus TCP/IP and PROFINET RT
- Onboard advanced motion controller for 1.5 axis motion control
- Ethernet webpages hosted onboard the M750 Ethernet drive
- Reduced downtime with machine safety
  - i. Integrated dual Safe Torque Off (STO)
  - ii. Meets SIL3 and PLe
  - iii. Safe motion and CIP Safety with MiS250 option (see p.9)

## Advanced Motion Controller onboard

Advanced 1.5 axes motion controller, key features include:

- 250  $\mu$ s cycle time
- Interpolated cam
- Motion profile generator
- Homing functions
- Electronic gearbox
- High speed position freeze

## RTMoE

Digitax HD's standard Ethernet supports RTMoE (Real-Time Motion over Ethernet) which provides synchronised communication between drives using the Precision Time Protocol as defined by IEEE1588 V2:

- Distributed clocks are used to automatically synchronise the position, speed and current loops across all drives
- High speed network synchronisation with less than 1  $\mu$ s jitter (typically <200 ns) and 250  $\mu$ s cycle time for synchronous cyclic data



EtherNet/IP

PROFINET

Modbus TCP/IP

RTMoE

I4.0 READY

SIL3

TÜVRheinland® Precisely Right.

PLe







# MULTI-PROTOCOL

## A single drive that does it all

Control Techniques' philosophy has always been to support innovators, regardless of which communications protocol they may use. It's for them that we've developed the most flexible servo drive platform on the market.

Having multiple protocols supported by one drive means that different systems can share one design, reducing engineering effort and complexity, and helping to rationalise inventory of parts and spares.

But we didn't stop there. Today Digitax drives offer EtherNet/IP, Modbus TCP/IP, RTMoE and PROFINET RT as standard, on a single drive platform, simultaneously.

 RTMoE	 250 µs drive-to-drive synchronous data transfer	 TCP/IP	 Maximum of up to 10 concurrent connections
EtherNet/IP	 Support for RPI as low as 2 ms		 Support for 1 ms cyclic link cycle times

## PLC Controlled Motion

PLC Controlled Motion facilitates the integration of Control Techniques drives into major PLC architectures, simplifying the process to the point where our drives can be swapped into an application in a matter of hours.

A single installation will load all the function blocks and documentation required, as well as example projects to get the application up and running as quickly as possible. With the guided setup sequence provided inside the Connect software tool, users are taken through the setup process step-by-step, resulting in a ready-to-use configuration that can be loaded straight into the drive.

Utilising the high-performance Advanced Motion Controller inside Digitax HD once again yields significant performance benefits, and gives the possibility to create complex motion completely decoupled from the performance and computational power of the external PLC.



### Frequency Control

Allows frequency control of an open-loop axis.



### RPM Control

Allows speed control of a closed-loop (including sensorless) axis.



### Speed Control

Allows speed control of an axis, with dynamic control over motion parameters. With dedicated jogging reference.



### Position Control

Single motion or up to 10 index moves can be defined and executed.

Multiple homing modes.



### Electronic Gearbox Control

Electronic gearbox scaled motion

Master reference switchable at the PLC at run-time.

Multiple homing modes.

# M753 ETHERCAT

For high-performance centralised motion control applications

## Digitax M753 EtherCAT

- Digitax M753 features an integrated 2-port EtherCAT switch for easy integration in centralised motion control applications
- EoE (Ethernet over EtherCAT) support allows PC tool connection for commissioning and monitoring over the EtherCAT network
- The station alias can be dynamically assigned by the EtherCAT master, or hardwired with the two rotary switches built into the display
- An optional RS485 adaptor is available, providing a back-up PC tool connection in case of network failure

## High performance with flexibility

Operate with any automation product via EtherCAT

- Operate with motion controllers, motion PLCs and Industrial PCs via built-in EtherCAT
- Dual 100Mbps EtherCAT interfaces for use with in-line topologies
- Non-cyclic data communication using the CANopen over EtherCAT (CoE) mailbox

Flexibility for all applications achieved through full access to drive functions

- CANopen over EtherCAT (CoE) with CiA-402 profile including:
  - Cyclic synchronous position mode
  - Cyclic synchronous velocity mode
  - Cyclic synchronous torque mode
  - Homing mode
  - Interpolated position mode
  - Velocity mode
  - SDO access to all profile objects and drive parameters





## Improved productivity with machine safety

The built-in dual Safe Torque Off is certified to SIL3 / PL<sub>e</sub>.

With the MiS250 option(\*), the integrated safety can be extended to include

- Safe Motion
  - i. Safe Stop 1 (SS1)
  - ii. Safe Stop 2 (SS2)
  - iii. Safely Limited Speed (SLS)
  - iv. Safe Operating Stop (SOS)
  - v. Safe Direction (SDI)
  - vi. Safe Speed Monitor (SSM)
  - vii. Safe Emergency Stop (SES)
  - viii. Safely Limited Position (SLP)
  - ix. Safely Limited Acceleration (SLA)
  - x. Safe Brake Control (SBC)
  - xi. Two Hand Control
- Fail Safe over EtherCAT
  - xii. Up to 32 booleans and 4 integers communication interface
  - xiii. Safe speed and position transfer to safety controller

(\* refer to page 9

## Rapid and flexible commissioning

- Ethernet over EtherCAT (EoE) for PC tool communication
- File over EtherCAT (FoE) for drive parameter transfer
- Rotary dials can be used for local setting of the station alias

# MACHINE CONTROLLERS

# M754 MCI

Servo drive and controller in one

## Digitax M754 MCI

A powerful MCI second processor onboard the Digitax M754 servo drive brings a whole host of machine design opportunities.

The onboard MCI processor executes comprehensive programs that can control multiple drives and motors simultaneously across real-time networks

Onboard Ethernet using RTMoE (Real Time Motion over Ethernet) provides synchronization and communication between drives using the Precision Time Protocol (PTP) as defined by IEEE1588 V2

Simple integration with external components such as Remote I/O, HMIs and PLCs can be achieved with Modbus TCP/IP on the integrated 2-port standard Ethernet switch.

- Two Ethernet ports with an internal switch
- Support for standard Ethernet protocols
- RTMoE for synchronised cyclic data at 250  $\mu$ s
- Modbus TCP/IP master



# MACHINE CONTROL STUDIO

## Fast Programming and Commissioning

The Machine Control Studio programming environment provides a flexible and intuitive environment for programming automation and motion control features.

### The software provides programming for:

- Onboard PLC
- Integrated MCI on M754
- MCI200 or MCI210 integrated machine control modules
- Ethernet network data configurations

### Productivity features also supported:

- Intuitive IntelliSense functionality helps to write consistent and robust programs speeding up software development
- Programmers have access to a vibrant Open-source community for function blocks
- Machine Control Studio also supports customers' own function block libraries

## Familiar automation programming languages

The programming environment is fully IEC 61131-3 compliant and therefore familiar, fast and easy to use for control engineers around the world. The following IEC 61131-3 programming languages are supported:

- Structured Text (ST)
- Function Block Diagram (FBD)
- Structured Function Chart (SFC)
- Ladder Diagram (LD)
- Instruction List (IL)
- Continuous Function Chart (CFC)



Feature	Digitax HD onboard PLC	MCI Option Module /M754
Breakpoints	-	Yes
Source code upload/download	-	Yes
Online change	-	Yes
Trigonometric functions	-	Yes
64 bit data types	-	Yes
Real-time task(s)	Yes (min 4ms)	Yes (min 250 µs)
Customisable drive menu	Yes	Yes
Variable tracing	-	Yes
Tasks available	1 x Freewheeling task, 1 x Clock task	1 x Freewheeling task, 1 x Position task, 1 x Initial task, 4 x Clock tasks, 1 x Error task, 4 x Event tasks
Centralised controller	-	Yes
Decentralised controller	Yes	Yes

# M751 BASE

Base drive for configuration flexibility

## Digitax M751 flexibility

- Two option slots for functionality extension and customisation
- Built-in Modbus RTU over RS485 communications
- Onboard Advanced Motion Controller for 1.5 axis motion control
- Analog and pulse/direction control for centralised motion
- Improved productivity with machine safety
  - i. Integrated dual Safe Torque Off
  - ii. Meets SIL3 and PLe

## Advanced Motion Controller onboard







Advanced 1.5 axes motion controller, key features include:

- 250  $\mu$ s cycle time
- Motion profile generator
- Electronic gearbox
- Interpolated cam
- Homing functions
- High speed position freeze



# OPTION MODULE FLEXIBILITY

Digitax HD supports a range of communications, I/O, feedback and machine control option modules.

Option module	Description
<b>Feedback</b>	
<b>SI-Universal Encoder</b> 	Encoder input and output interface supporting Quadrature, SinCos, EnDat and SSI encoders.
<b>SI-Encoder</b> 	Quadrature encoder input interface module.
<b>I/O</b>	
<b>SI-I/O</b> 	Extended I/O interface module to increase the number of analog and digital I/O points on the drive.  Programmable I/O functions for: 4 x DI/DI, 3 x AI / DI, 1 x AO / DI, 2 x Relays
<b>Communications</b>	
<b>SI-EtherCAT</b> 	<b>SI-CANopen</b> 
<b>SI-PROFINET</b> 	<b>SI-PROFIBUS</b> 
<b>SI-Ethernet*</b> 	<b>SI-POWERLINK</b> 
<b>SI-DeviceNet</b> 	<b>SI-INTERBUS</b> 

Option module	Description
<b>Second processor for Logic and Motion</b>	
<b>MCi200</b> 	Advanced machine control using industry standard IEC61131-3 programming languages
<b>MCi210</b> 	Extended advanced machine control using industry standard IEC61131-3 programming languages and integrated Ethernet
<b>SI-Apps Compact</b> 	Compatible module allows legacy SyPTPro application programs to be re-compiled for Digitax HD
<b>PTi210</b> 	PTi210 Simple, fast and effective motion control solutions using intuitive PowerTools Studio Software
<b>Safety</b>	
<b>MiS250</b> 	Integrated safe motion up to SIL3 / PLe. Support for CIP Safety and Safety over EtherCAT (FSoE)

# SCALABLE MOTION CO

## Small machine

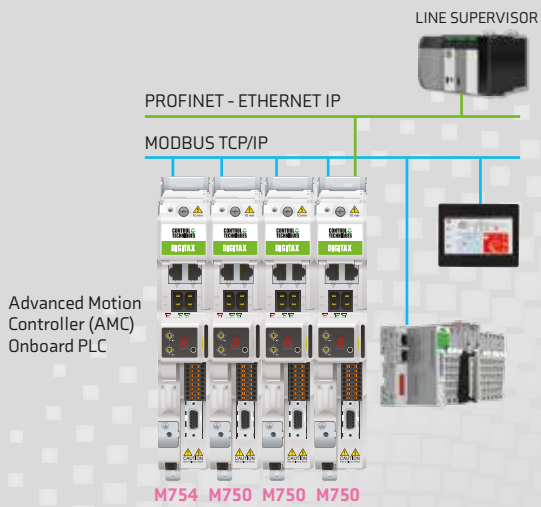

High-end controller  
11-50 axes

Mid-range controller  
5-10 axes

Full machine controller  
1-4 axes

Simple on-board logic  
1.5 axis

## Single-Axis machine / Machine module

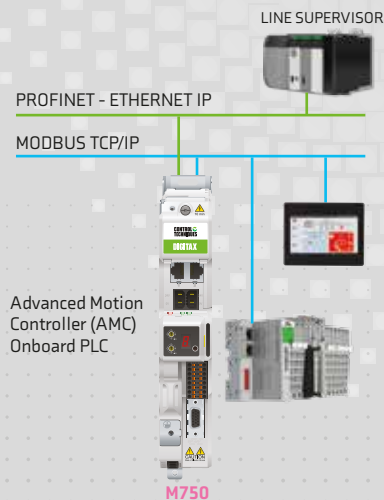

M754



	AMC Built-in Advanced Motion Controller	M754 with built-in M750
Speed control	✓	✓
Positioning	✓	✓
Gearing	✓	✓
Simple cam profiles	✓	✓
Advanced cam profiles	✓	✓
High-speed position freeze	✓	✓
Digital cam switch		✓
Interpolated Motion		✓
	Drive based	

# CONTROL



MCe  
Stand-alone Multi-axis Machine  
Controller

- ✓
- ✓
- ✓
- ✓
- ✓
- ✓
- ✓

MCz  
Industrial PC

- ✓
- ✓
- ✓
- ✓
- ✓
- ✓
- ✓

Controller based

For more information on our MCe & MCz stand-alone machine controllers, please visit [www.controltechniques.com](http://www.controltechniques.com) or contact one of our sales representatives.

## Medium machine

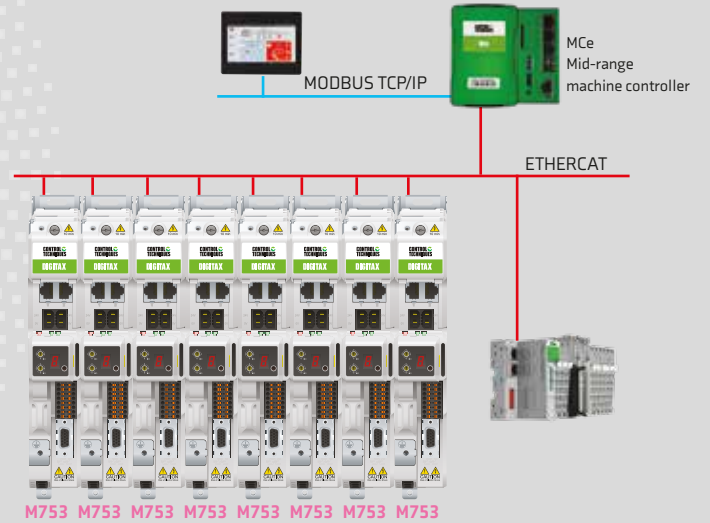

## Large machine

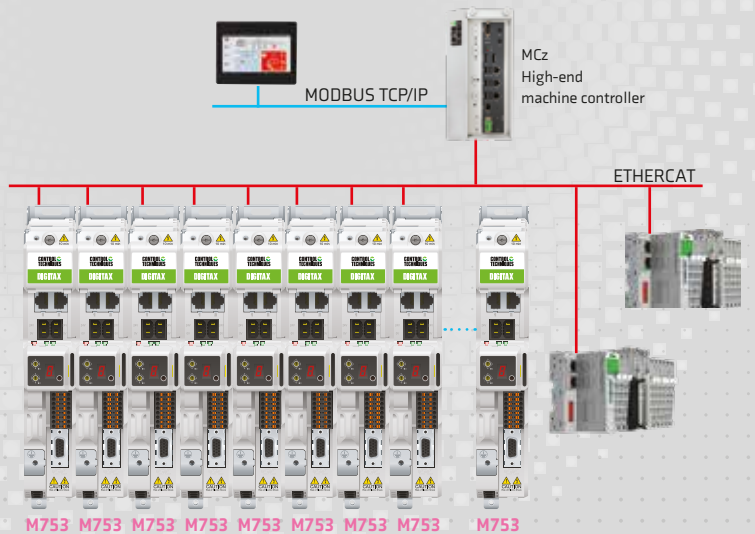

# UNIMOTOR HD

# HIGH DYNAMIC

# SERVO MOTOR

For pulse duty applications

Unimotor HD is a high dynamic brushless AC servo motor range designed for use in pulse duty applications where rapid acceleration and deceleration is required.

## High torque to inertia ratio

Unimotor HD has a high power to weight ratio, meaning that it can be easily integrated into the smallest, most demanding applications such as industrial robotics, pick & place and packaging.



### Patented rotor technology

High torque to inertia ratio for high dynamic performance

### Compact but powerful

### Parking brake available





Supported by rigorous testing for performance and reliability

Windings to suit 400 V and 200 V

Rated speeds include 1,000 rpm – 6,000 rpm depending on motor size

IP65 conformance: sealed against water spray and dust when mounted and connected

Segmented stator design for high power density and compactness

0.7 Nm to 85.0 Nm (6.2 lb-in to 752 lb-in) and up to 300% overload

# ENERGY EFFICIENCY

## M75C Capacitor Module

Available in 200 V and 400 V variants, the M75C CapShare Capacitor Module is contained within a M75x Frame 1 chassis measuring 40mm width. M75C CapShare is designed for use in multi-axis applications to offer:

- Ways to cope with fluctuations in power supply by increasing the ability to ride through short cut outs in mains power
- Dynamic performance with quick-access energy storage for fast acceleration / deceleration
- Energy efficiency as more energy can be stored rather than being wasted as heat

Multiple M75C CapShare units can be paralleled in a scalable architecture, which is also quick and easy to install with DIN rail alignment, and easy DC bus paralleling.

## M75C CapShare Capacitor Module

Product code	M75C-01201740	M75C-01400725
Rated Voltage	200 V	400 V
Onboard capacitance	1740 µF	725 µF
DC supply	200-370 Vdc	360-760 Vdc
External 24 Vdc supply for control		Yes
Internal Current Inrush limitation Circuit		Yes
Status Relay (Potential Free Contacts)		Yes
Status Indication On Front Panel		Single LED
Thermal Protection		Yes

Easy connection to a drive or drive group can be achieved with the multiaxis kit (9500-1048) – no additional fusing required.

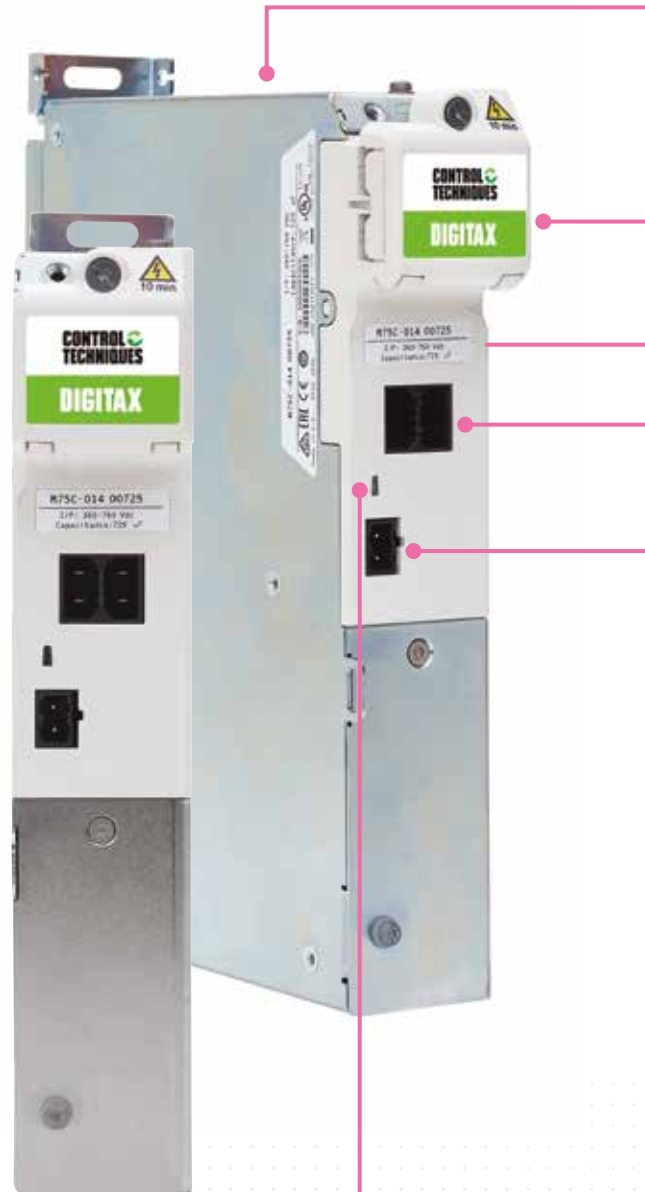

Status LED

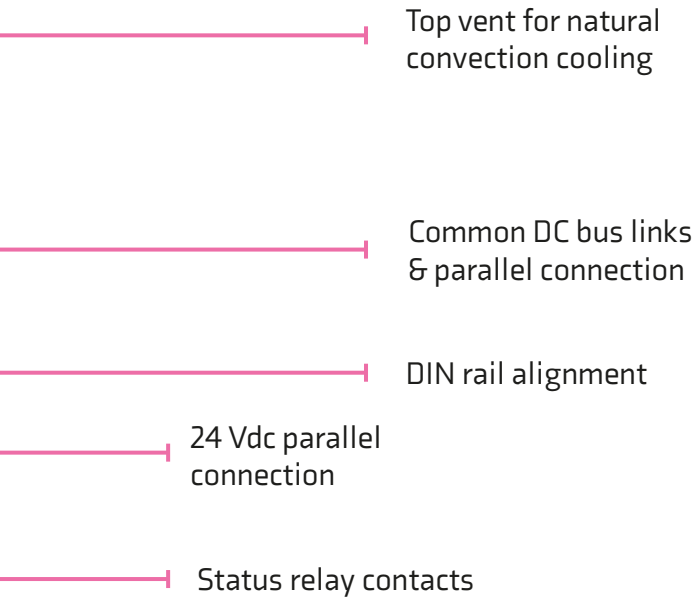

### Common DC bus and Active Front End

Easy common DC bus connection enables braking energy to be recycled within the drive system, optimising energy usage.

Any Digitax HD drive can be used as an Active Front End (AFE) to create a regenerative AC drive system.

Active Front End also provides power factor control for power quality management, and greatly reduced unwanted power harmonics.

### Active Front End Kits

Voltage	Model (M75X-...)	Switching Frequency Filter Capacitors	Regenerative Choke	Switching Frequency Filter Choke
		Product codes	Product codes	Product codes
200 V	2200090	1610-8104	4401-0310	4401-1311
	2200120	1610-8104	4401-0312	4401-1312
	3200160	1610-8104	4401-0313	4401-1313
400 V	2400080	1610-8104	4401-0405	4401-0162
	2400105	1610-8104	4401-0406	4401-0163
	3400135	1610-8104	4401-0407	4401-0164
	3400160	1610-8104	4401-0407	4401-0164

# DIGITAX HD

# SPECIFICATION

Servo Series Specification		M753 EtherCAT	M751 Base	M750 Ethernet	M754-MCi
Performance	Update Rates	Current Loop Update: 62 $\mu$ s			
		Speed Loop Update: 250 $\mu$ s			
		Position Loop Update: 250 $\mu$ s			
	Overload	*Closed-loop Overload: Maximum closed loop peak current for 0.25 s (from cold: 300 % for 8 s or 200 % for 60 s)			
		*Open-loop Overload: Maximum open loop peak current for 8 s (from cold: 150 % for 100 s)			
Max Output Frequency	550 Hz (RFC-A and RFC-S) 599 Hz (Open Loop)				
Switching Frequency	Configurable range: 2, 3, 4, 6, 8, 12, 16 kHz				
	Default: 8kHz				
Ultraflow™ Technology	Adjustable Venting	Top venting or rear venting (with optional kit)			
	Intelligent Fan Control	Temperature controlled fan operation with user adjustable speed limit			
	Managed Internal Airflow	Managed airflow for maximum ingress protection			
Onboard Intelligence	Motion	Advanced Motion Controller		MCI	
		Parameterised motion		Programmable motion	
		1.5 Axes		Up to 5 Axes	
	PLC	Positioning digital lock control		Positioning digital lock control camming	
		Real-time tasks			
Control	Motor Control Modes	Onboard PLC			
		Onboard Machine Controller			
	Control Modes	IEC61131-3 programming (IL, LD, FBD, SFC, ST, CFC)			
		V/F, Open loop vector, RFC-A (Sensorless or with feedback 'Closed Loop'), RFC-S (Sensorless or with feedback 'Closed Loop')			
		Position control, speed control, torque control			
Control Features	Stationary autotune for permanent magnet motors				
	Advanced bi-quad filters for suppression of mechanical resonances				

RFC-S: Rotor Flux Control for Synchronous (permanent magnet brushless) motors

RFC-A: Rotor Flux Control for Asynchronous (induction) motors

\* The stated percentages apply only to three phase continuous current

		M753 EtherCAT	M751 Base	M750 Ethernet	M754-MCi
<b>Interface</b>	Onboard Communications	2-port EtherCAT switch	2-port RS485	2-port Ethernet switch	2-port Ethernet switch
	Fieldbus	EtherCAT	Modbus RTU	Modbus TCP/IP, EtherNet/IP, PROFINET RT	Modbus TCP/IP
	Real Time Motion	EtherCAT (CoE)	None	RTMoE	RTMoE
	Analog I/O	1 Analog Input $\pm 10V$ , 12 bits (11 bits + sign)			
	Digital I/O	2 DI, 2 DO (100 mA), 1 motor brake output (1 A, max 1.3 A)			
	Pulse Train Input	Frequency/Direction 5 V differential, 500 kHz			
	Encoder Feedback	2 x Encoder input and 1 simulated encoder output			
	Supported Encoders	Resolver, Quadrature, AB Servo, SinCos, EnDat (2.1/2.2), SSI, BiSS, Hiperface			
	Safety	2 x Safe Torque Off (STO) via terminal, PLe, SIL3			
<b>Commissioning</b>	Interface	Ethernet over EtherCAT (EoE)	RS485	Ethernet	Ethernet
	Commissioning Tool	Connect			
	Motion Programming Tool	Machine Control Studio			
<b>General</b>	Mechanical Attributes	Removable cable screen clamp			
		User replaceable fan(s)			
		Conformal coating			
	Backup	SD Card			
		Electronic motor nameplate parameter storage (HIPERFACE, Endat 2.2, BiSS)			
	Braking	Braking resistor: external / drive mountable			
		Braking chopper: integrated			
	Multi-axis	Busbars for common DC bus and earthing			
Quick Links for 24 V distribution					
Display	Yes	Optional	Yes	Yes	

# ENVIRONMENT SAFETY AND ELECTRICAL CONFORMANCE

## Environment

- IP rating: M75x drives are rated to IP20 (dry, non-conductive contamination)
- UL open class
- Ambient temperature -20 °C (-4 °F) to 40 °C (104 °F) as standard. Up to 55 °C (131 °F) with derating
- Humidity 95 % maximum (non-condensing) at 40 °C (104 °F)
- 1,000 m to 3,000 m (3,300 ft to 9,900 ft) above sea level: de-rate the maximum output current from the specified figure by 1% per 100 m (330 ft) above 1,000 m (3,300 ft)
- Storage temperature -40 °C (-40 °F) to 70 °C (158 °F)
- Mechanical Shock Tested in accordance with IEC 60068-2-27
- Random Vibration: Tested in accordance with IEC 60068-2-64

## Safety

- Safe Torque Off independently assessed by TÜV to IEC 61800-5-2
- SIL 3 and EN ISO 13849-1 PLe
- UL 61800-5-1 (Electrical Safety)

## Electrical conformance

- Electromagnetic Immunity complies with EN 61800-3 and EN 61000-6-2
- With onboard EMC filters, complies with EN 61800-3 (2nd environment)
- EN 61000-6-3 and EN 61000-6-4 with optional EMC filter
- IEC 60146-1-1 supply conditions
- IEC 61800-5-1 (Electrical Safety)
- IEC 61131-2 I/O





# DIGITAX HD & UNIMOTOR HD MOTOR AND DRIVE COMBINATIONS

400 V range – 0.7 to 51 Nm (6.2 to 451 lb-in) with 300% peak stall torque  
200 V range – 0.7 to 45 Nm (6.2 to 398 lb-in) with 300% peak stall torque

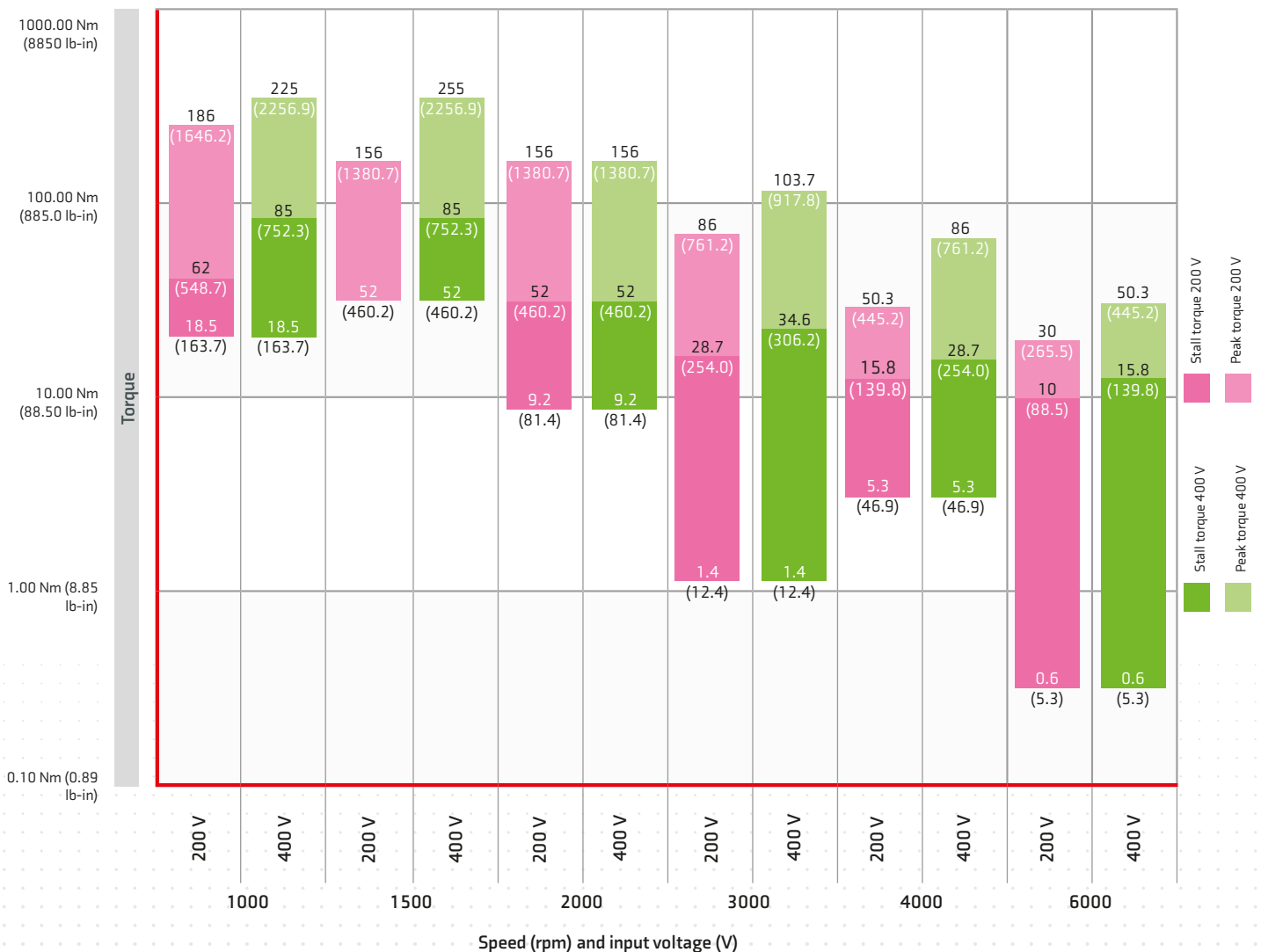



200 V Three Phase

For drive ratings, please see page 46 and motor ratings from page 50-61  
 \* Acceleration time to nominal speed is based on 1:1 motor to load inertia ratio

Nominal speed 6000 rpm - 300% overload													
Motor	Drive	Hybrid Cable	Stall Torque		Peak Torque		Inertia		Drive Cont. Current [A]	Drive Capacitance [µF]	Motor Cont. power		Time to 6000 rpm [ms]*
			[Nm]	[lb-in]	[Nm]	[lb-in]	[kg-cm <sup>2</sup> ]	[lb-in-sec <sup>2</sup> ]			[kW]	[hp]	
060EDA60	M75x-01200022	HYBAxAxxxx	0.6	5.3	2.2	19.5	0.18	0.00016	2.2	580	0.4	0.54	10.1
060EDB60	M75x-01200040	HYBAxAxxxx	1.3	11.5	4.5	39.8	0.33	0.00029	4	580	0.8	1.07	9.3
060EDC60	M75x-01200040	HYBAxAxxxx	1.9	16.8	6.7	59.3	0.48	0.00042	4	580	1.2	1.61	10.7
067EDA60	M75x-01200040	HYBAxAxxxx	1.4	12.4	4.3	38.1	0.30	0.00027	4	580	0.8	1.07	8.8
067EDB60	M75x-01200065	HYBAxAxxxx	2.5	22.1	7.5	66.4	0.53	0.00047	6.5	580	1.4	1.88	8.9
067EDC60	M75x-01200040	HYBAxAxxxx	3.6	31.9	10.9	96.5	0.75	0.00066	4	580	1.2	1.61	16.7
067EDD60	M75x-02200120	HYBAxAxxxx	4.6	40.7	14.3	126.6	0.94	0.00083	12	1160	2.5	3.35	8.3
089EDA60	M75x-02200090	HYBAxAxxxx	3.1	27.4	9.3	82.3	0.87	0.00077	9	1160	1.7	2.28	11.7
089EDB60	M75x-02200120	HYBAxAxxxx	5.3	46.9	16.0	141.6	1.61	0.00142	12	1160	2.4	3.22	12.6
089EDC60	M75x-03200160	HYBBxAxxxx	7.8	69.0	23.3	206.2	2.34	0.00207	16	1880	3.1	4.16	13
115EDA60	M75x-02200120	HYBAxAxxxx	5.7	50.4	17.1	151.3	2.40	0.00212	12	1160	2.3	3.08	17.8
115EDB60	M75x-02200090	HYBAxAxxxx	10.0	88.5	30.0	265.5	4.41	0.00390	9	1160	2.7	3.62	43.7
Nominal speed 4000 rpm - 300% overload													
089EDB40	M75x-02200090	HYBAxAxxxx	5.3	46.9	16.0	141.6	1.61	0.00142	9	1160	1.9	2.55	8.4
089EDC40	M75x-02200120	HYBAxAxxxx	7.8	69.0	23.3	206.2	2.34	0.00207	12	1160	2.7	3.62	8.4
115EDC40	M75x-03200160	HYBBxAxxxx	14.3	126.6	42.9	379.7	6.39	0.00566	16	1880	3.6	4.83	15.9
142EDB40	M75x-03200160	HYBBxBxxxx	15.8	139.8	50.3	445.2	11.00	0.00974	16	1880	4.7	6.30	27.4
Nominal speed 3000 rpm - 300% overload													
067EDA30	M75x-01200022	HYBAxAxxxx	1.4	12.4	4.3	38.1	0.30	0.00027	2.2	580	0.4	0.54	4.4
067EDB30	M75x-01200040	HYBAxAxxxx	2.5	22.1	7.5	66.4	0.53	0.00047	4	580	0.8	1.07	4.4
067EDC30	M75x-01200040	HYBAxAxxxx	3.6	31.9	10.9	96.5	0.75	0.00066	4	580	1.1	1.48	4.3
067EDD30	M75x-01200065	HYBAxAxxxx	4.6	40.7	14.3	126.6	0.94	0.00083	6.5	580	1.4	1.88	4.1
089EDA30	M75x-01200040	HYBAxAxxxx	3.1	27.4	9.3	82.3	0.87	0.00077	4	580	0.9	1.21	5.9
089EDB30	M75x-01200065	HYBAxAxxxx	5.3	46.9	16.0	141.6	1.61	0.00142	6.5	580	1.5	2.01	6.3
089EDC30	M75x-02200090	HYBAxAxxxx	7.8	69.0	23.3	206.2	2.34	0.00207	9	1160	2.1	2.82	6.3
089EDD30	M75x-02200120	HYBAxAxxxx	10.0	88.5	30.6	270.8	3.20	0.00283	12	1160	2.6	3.49	6.6
115EDA30	M75x-01200065	HYBAxAxxxx	5.7	50.4	17.1	151.3	2.40	0.00212	6.5	580	1.5	2.01	8.8
115EDB30	M75x-02200120	HYBAxAxxxx	10.0	88.5	30.0	265.5	4.41	0.00390	12	1160	2.4	3.22	9.2
115EDC30	M75x-03200160	HYBBxAxxxx	14.3	126.6	42.9	379.7	6.39	0.00566	16	1880	3.2	4.29	9.4
142EDA30	M75x-02200120	HYBAxAxxxx	9.2	81.4	27.6	244.3	5.60	0.00496	12	1160	2.3	3.08	12.8
142EDB30	M75x-03200160	HYBBxBxxxx	15.8	139.8	50.3	445.2	11.00	0.00974	16	1880	4	5.36	15.5
142EDC30	M75x-03200160	HYBBxBxxxx	22.8	201.8	68.3	604.5	17.00	0.01505	16	1880	4.7	6.30	23.9
142EDD30	M75x-02200120	HYBAxBxxxx	28.7	254.0	86.0	761.2	22.10	0.01956	12	1160	3.5	4.69	41.5
190EDA30	M75x-03200160	HYBBxBxxxx	18.5	163.7	51.0	451.4	22.00	0.01947	16	1880	4.7	6.30	31
Nominal speed 2000 rpm - 300% overload													
115EDC20	M75x-02200120	HYBAxAxxxx	14.3	126.6	42.9	379.7	6.39	0.00566	12	1160	2.4	3.22	6.2
115EDD20	M75x-03200160	HYBBxAxxxx	18.4	162.9	55.3	489.4	8.38	0.00742	16	1880	3.2	4.29	6.4
142EDA20	M75x-01200065	HYBAxAxxxx	9.2	81.4	27.6	244.3	5.60	0.00496	6.5	580	1.6	2.15	8.6
142EDB20	M75x-02200120	HYBAxAxxxx	15.8	139.8	50.3	445.2	11.00	0.00974	12	1160	2.9	3.89	9.2
142EDC20	M75x-03200160	HYBBxBxxxx	22.8	201.8	68.3	604.5	17.00	0.01505	16	1880	4.1	5.50	10.6
190EDC20	M75x-03200160	HYBBxBxxxx	49	433.7	156.0	1380.7	54.60	0.04833	16	1880	4.7	6.30	34.3

Nominal speed 1500 rpm - 300% overload													
Motor	Drive	Hybrid Cable	Stall Torque		Peak Torque		Inertia		Drive Cont. Current [A]	Drive Capacitance [ $\mu$ F]	Motor Cont. power		Time to 1000 rpm [ms]*
			[Nm]	[lb-in]	[Nm]	[lb-in]	[kg-cm <sup>2</sup> ]	[lb-in-sec <sup>2</sup> ]			[kW]	[hp]	
190EDC15	M75x-03200160	HYBBxBxxxx	49	433.7	156.0	1380.7	54.60	0.04833	16	1880	4.7	6.30	19.2
Nominal speed 1000 rpm - 300% overload													
190EDA10	M75x-01200065	HYBAxBxxxx	18.5	163.7	51.0	451.4	22.00	0.01947	6.5	580	1.8	2.41	9
190EDC10	M75x-03200160	HYBBxBxxxx	49	433.7	156.0	1380.7	54.60	0.04833	16	1880	4.7	6.30	8.5
190EDD10	M75x-03200160	HYBBxBxxxx	62.0	548.7	186.0	1646.2	70.90	0.06275	16	1880	4.7	6.30	11

## 400 V Three Phase

For drive ratings, please see page 45 and motor ratings from page 50 to 61.  
\* Acceleration time to nominal speed is based on 1:1 motor to load inertia ratio

Nominal speed 6000 rpm - 300% overload													
Motor	Drive	Hybrid Cable	Stall Torque		Peak Torque		Inertia		Drive Cont. Current [A]	Drive Capacitance [ $\mu$ F]	Motor Cont. power		Time to 6000 rpm [ms]*
			[Nm]	[lb-in]	[Nm]	[lb-in]	[kg-cm <sup>2</sup> ]	[lb-in-sec <sup>2</sup> ]			[kW]	[hp]	
060UDA60	M75x-01400015	HYBAxAxxxx	0.6	5.3	2.2	19.5	0.18	0.00016	1.5	110	0.4	0.54	10.1
060UDB60	M75x-01400015	HYBAxAxxxx	1.3	11.5	4.5	39.8	0.33	0.00029	1.5	110	0.8	1.07	11.5
060UDC60	M75x-01400030	HYBAxAxxxx	1.9	16.8	6.7	59.3	0.48	0.00042	3	110	1.2	1.61	9
067UDA60	M75x-01400030	HYBAxAxxxx	1.4	12.4	4.3	38.1	0.30	0.00027	3	110	0.8	1.07	8.8
067UDB60	M75x-01400042	HYBAxAxxxx	2.5	22.1	7.5	66.4	0.53	0.00047	4.2	110	1.4	1.88	8.9
067UDC60	M75x-02400060	HYBAxAxxxx	3.6	31.9	10.9	96.5	0.75	0.00066	6	290	1.9	2.55	8.7
067UDD60	M75x-02400060	HYBAxAxxxx	4.6	40.7	14.3	126.6	0.94	0.00083	6	290	2.5	3.35	8.3
089UDA60	M75x-01400042	HYBAxAxxxx	3.1	27.4	9.3	82.3	0.87	0.00077	4.2	110	1.7	2.28	11.7
089UDB60	M75x-02400080	HYBAxAxxxx	5.3	46.9	16.0	141.6	1.61	0.00142	8	290	2.4	3.22	12.6
089UDC60	M75x-02400105	HYBAxAxxxx	7.8	69.0	23.3	206.2	2.34	0.00207	10.5	290	3.1	4.16	12.6
115UDA60	M75x-02400080	HYBAxAxxxx	5.7	50.4	17.1	151.3	2.40	0.00212	8	290	2.3	3.08	17.7
115UDB60	M75x-03400135	HYBBxAxxxx	10.0	88.5	30.0	265.5	4.41	0.00390	13.5	470	3	4.02	18.5
142UDB60	M75x-03400160	HYBBxBxxxx	15.8	139.8	50.3	445.2	11.00	0.00974	16	470	4.4	5.90	36
Nominal speed 4000 rpm - 300% overload													
089UDB40	M75x-02400060	HYBAxAxxxx	5.3	46.9	16.0	141.6	1.61	0.00142	6	290	1.9	2.55	8.4
089UDC40	M75x-02400080	HYBAxAxxxx	7.8	69.0	23.3	206.2	2.34	0.00207	8	290	2.7	3.62	8.4
115UDC40	M75x-03400135	HYBBxAxxxx	14.3	126.6	55.3	489.4	6.39	0.00566	13.5	470	3.6	4.83	11
142UDB40	M75x-03400135	HYBBxAxxxx	15.8	139.8	50.3	445.2	11.00	0.00974	13.5	470	4.9	6.57	19
142UDD40	M75x-03400160	HYBBxBxxxx	28.7	254.0	86.0	761.2	22.10	0.01956	16	470	6.2	8.31	32.1

Nominal speed 3000 rpm - 300% overload													
Motor	Drive	Hybrid Cable	Stall Torque		Peak Torque		Inertia		Drive Cont. Current [A]	Drive Capacitance [µF]	Motor Cont. power		Time to 3000 rpm [ms]*
			[Nm]	[lb-in]	[Nm]	[lb-in]	[kg-cm <sup>2</sup> ]	[lb-in-sec <sup>2</sup> ]			[kW]	[hp]	
067UDA30	M75x-01400030	HYBAxAxxxx	1.4	12.4	4.3	38.1	0.30	0.00027	3	110	0.4	0.54	4.4
067UDB30	M75x-01400015	HYBAxAxxxx	2.5	22.1	7.5	66.4	0.53	0.00047	1.5	110	0.8	1.07	4.6
067UDC30	M75x-01400030	HYBAxAxxxx	3.6	31.9	10.9	96.5	0.75	0.00066	3	110	1.1	1.48	4.3
067UDD30	M75x-01400030	HYBAxAxxxx	4.6	40.7	14.3	126.6	0.94	0.00083	3	110	1.4	1.88	4.1
089UDA30	M75x-01400030	HYBAxAxxxx	3.1	27.4	9.3	82.3	0.87	0.00077	3	110	0.9	1.21	5.9
089UDB30	M75x-01400042	HYBAxAxxxx	5.3	46.9	16.0	141.6	1.61	0.00142	4.2	110	1.5	2.01	6.3
089UDC30	M75x-02400060	HYBAxAxxxx	7.8	69.0	23.3	206.2	2.34	0.00207	6	290	2.1	2.82	6.3
089UDD30	M75x-02400080	HYBAxAxxxx	10.0	88.5	30.6	270.8	3.20	0.00283	8	290	2.6	3.49	6.6
115UDA30	M75x-01400042	HYBAxAxxxx	5.7	50.4	17.1	151.3	2.40	0.00212	4.2	110	1.5	2.01	8.8
115UDB30	M75x-02400080	HYBAxAxxxx	10.0	88.5	30.0	265.5	4.41	0.00390	8	290	2.4	3.22	9.2
115UDC30	M75x-02400105	HYBAxAxxxx	14.3	126.6	42.9	379.7	6.39	0.00566	10.5	290	3.2	4.29	9.4
115UDD30	M75x-03400135	HYBBxAxxxx	18.4	162.9	55.3	489.4	8.38	0.00742	13.5	470	4.2	5.63	9.5
142UDA30	M75x-02400060	HYBAxAxxxx	9.2	81.4	27.6	244.3	5.60	0.00496	6	290	2.3	3.08	12.8
142UDB30	M75x-02400105	HYBAxAxxxx	15.8	139.8	50.3	445.2	11.00	0.00974	10.5	290	4	5.36	13.7
142UDC30	M75x-03400160	HYBBxAxxxx	22.8	201.8	68.3	604.5	17.00	0.01505	16	470	5.3	7.11	15.7
142UDD30	M75x-03400160	HYBBxBxxxx	28.7	254.0	86.0	761.2	22.10	0.01956	16	470	6	8.05	18.1
142UDE30	M75x-03400160	HYBBxBxxxx	34.6	306.2	103.7	917.8	27.20	0.02407	16	470	6.6	8.85	22.3
190UDA30	M75x-03400135	HYBBxBxxxx	18.5	163.7	51.0	451.4	22.00	0.01947	13.5	470	4.9	6.57	27.1
190UDB30	M75x-03400160	HYBBxBxxxx	32.7	289.4	95.0	840.8	38.30	0.03390	16	470	7.9	10.59	31.3
Nominal speed 2000 rpm - 300% overload													
115UDC20	M75x-02400060	HYBAxAxxxx	14.3	126.6	42.9	379.7	6.39	0.00566	6	290	2.4	3.22	6.2
115UDD20	M75x-02400080	HYBAxAxxxx	18.4	162.9	55.3	489.4	8.38	0.00742	8	290	3.2	4.29	6.4
142UDA20	M75x-01400042	HYBAxAxxxx	9.2	81.4	27.6	244.3	5.60	0.00496	4.2	110	1.6	2.15	8.5
142UDB20	M75x-02400080	HYBAxAxxxx	15.8	139.8	50.3	445.2	11.00	0.00974	8	290	2.9	3.89	9.2
142UDC20	M75x-02400105	HYBAxAxxxx	22.8	201.8	68.3	604.5	17.00	0.01505	10.5	290	4.1	5.50	10.4
190UDC20	M75x-03400160	HYBBxBxxxx	49	433.7	156.0	1380.7	54.60	0.04833	16	470	8	10.73	19.9
Nominal speed 1500 rpm - 300% overload													
190UDC15	M75x-03400160	HYBBxBxxxx	52.0	460.2	156.0	1380.7	54.60	0.04833	16	470	7.3	9.79	11.2
190UDF15	M75x-03400160	HYBBxBxxxx	85.0	752.3	255.0	2256.9	103.50	0.09161	16	470	8	10.73	21.2
Nominal speed 1000 rpm - 300% overload													
190UDA10	M75x-01400042	HYBAxBxxxx	18.5	163.7	51.0	451.4	22.00	0.01947	4.2	110	1.8	2.41	9
190UDF10	M75x-03400160	HYBBxBxxxx	85.0	752.3	255.0	2256.9	103.50	0.09161	16	470	8	10.73	9.4

# MODULAR MULTI-AXIS CONFIGURATION

## Sizing the common DC bus

### Basic sizing of your system in 4 easy steps

- 1 Choose drive & motor combination based on speed and torque requirements [see pages 33 to 35](#)
- 2 Note nominal power & drive capacitance for each combination
- 3 Choose the drive to act as power supply for the drive group. Usually the largest drive
- 4 Check that:
  - sum of drive capacitance  $\leq$  maximum capacitance\*\*
  - sum of nominal power  $\leq$  maximum input power\*\*
 (Refer to tables opposite)

Digitax HD drives have a high capacity input power stage, allowing for a group of drives on a common DC bus to be powered by a single AC connection.

Alternatively, for larger configurations an external DC source can be used, such as a larger frame Unidrive M.

\* External AC Line Reactor required. Please refer to the Installation and Technical Guide.  
 \*\* If any of the values are exceeded, the system needs to be split in groups and the procedure repeated for each group.

		200V			
		Max Capacitance (µF)	Internal Capacitance (µF)	Max Input Power (kW)	Max Input Power (hp)
Size 1	M75x-01200022				
	M75x-01200040	5800	580	4 / 5.2*	5.4 / 7.0*
	M75x-01200065				
Size 2	M75x-02200090	4640	1160	5.3 / 6.9*	7.1 / 9.3*
	M75x-02200012				
Size 3	M75x-03200160	3760	1880	6.3 / 10*	8.5 / 13.4*

		400V			
		Max Capacitance (µF)	Internal Capacitance (µF)	Max Input Power (kW)	Max Input Power (hp)
Size 1	M75x-01400015				
	M75x-01400030	1900	110	6.5 / 8.5*	8.7 / 11.4*
	M75x-01400042				
Size 2	M75x-02400060				
	M75x-02400080	2030	290	8.7 / 11.4*	11.7 / 15.3*
	M75x-02400105				
Size 3	M75x-03400135	2210	470	10 / 13*	13.4 / 17.4*
	M75x-03400160				

**NOTE:** The number of drives that can be connected on a common DC bus group depends on the total installed capacitance, the power rating of the input stage and the power profile of each axis. There is also a limit of 10 drives for the 24 Vdc link.

**For optimised sizing please refer to the Installation and Technical Guide.**

# DIGITAX HD DRIVES

## PRODUCT CODE STRUCTURE

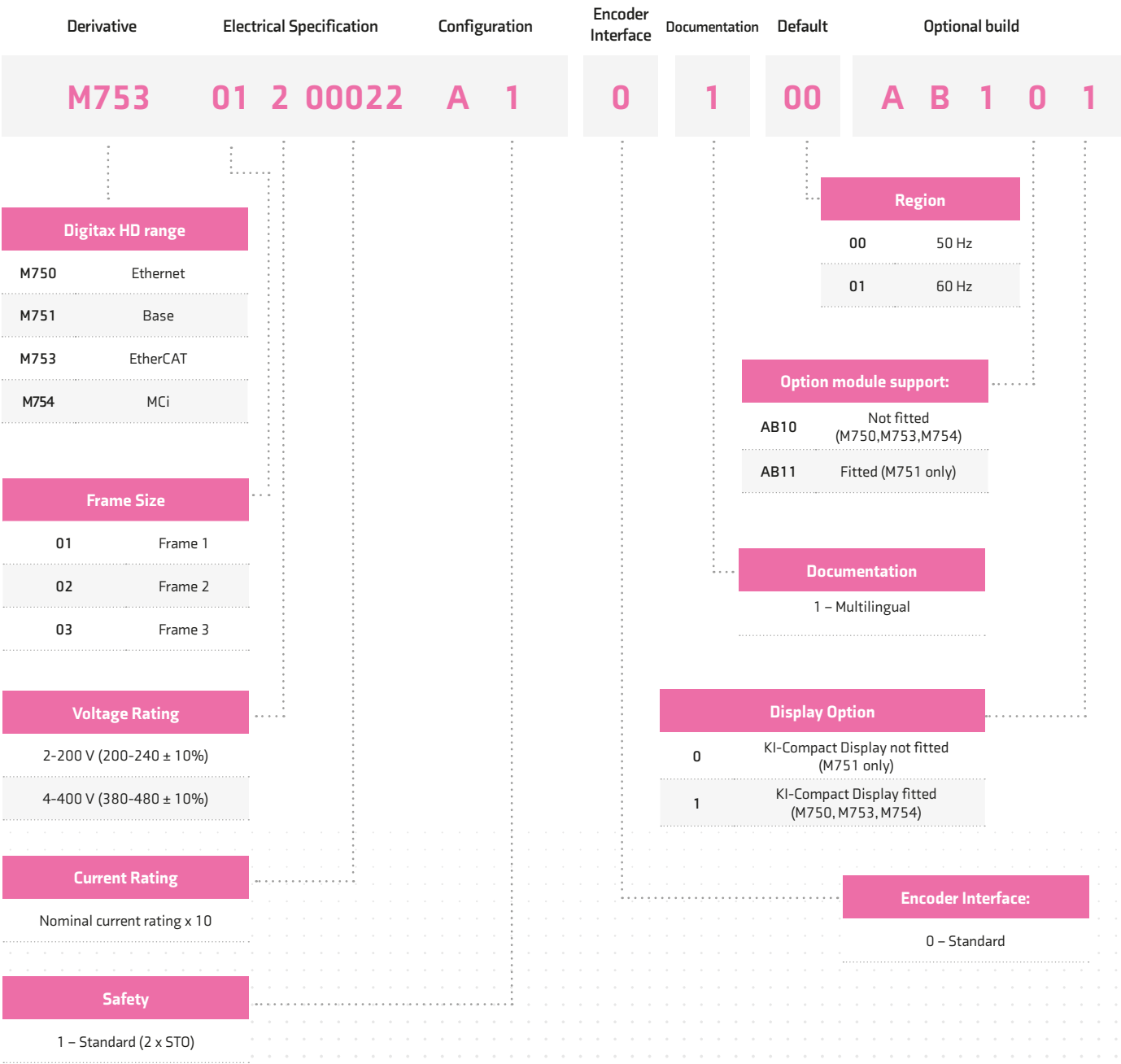

# UNIMOTOR HD MOTORS

## PRODUCT CODE STRUCTURE



<sup>1</sup> See "Recommended power connector size" in motor rating tables p. 50 onwards

Additional feedback options available on request.

for Functional Safety up to SIL 3 please add -SRES at the end of the product code

# CABLES AND CONNECTIONS

# POWER CABLE

## PRODUCT CODE STRUCTURE

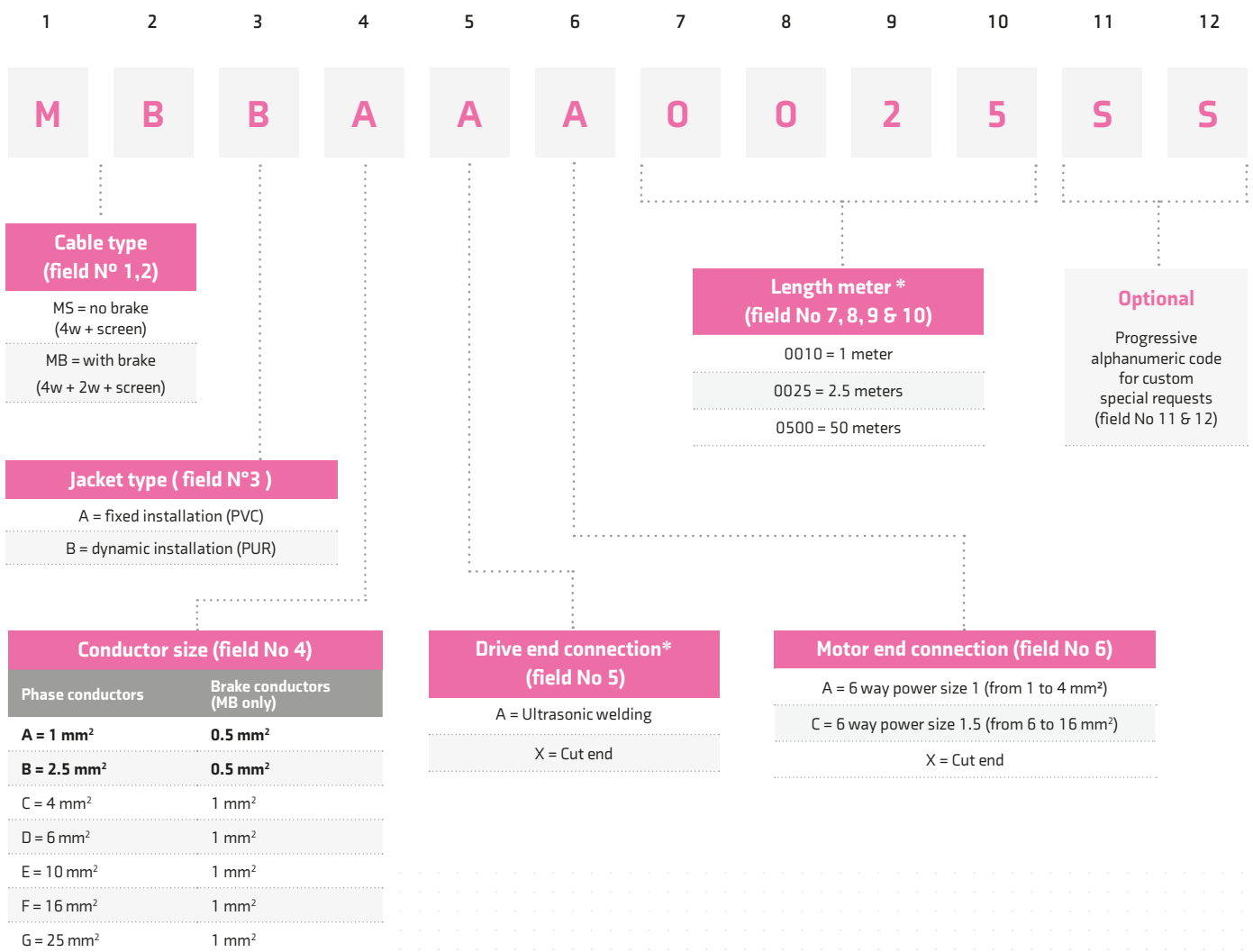

\* Cable length always rounded up to the next half meter; Eg. 2.1 will be changed to a 2.5 meter cable.  
Maximum cable length is 50m

# CABLES AND CONNECTIONS

# SIGNAL CABLE

## PRODUCT CODE STRUCTURE

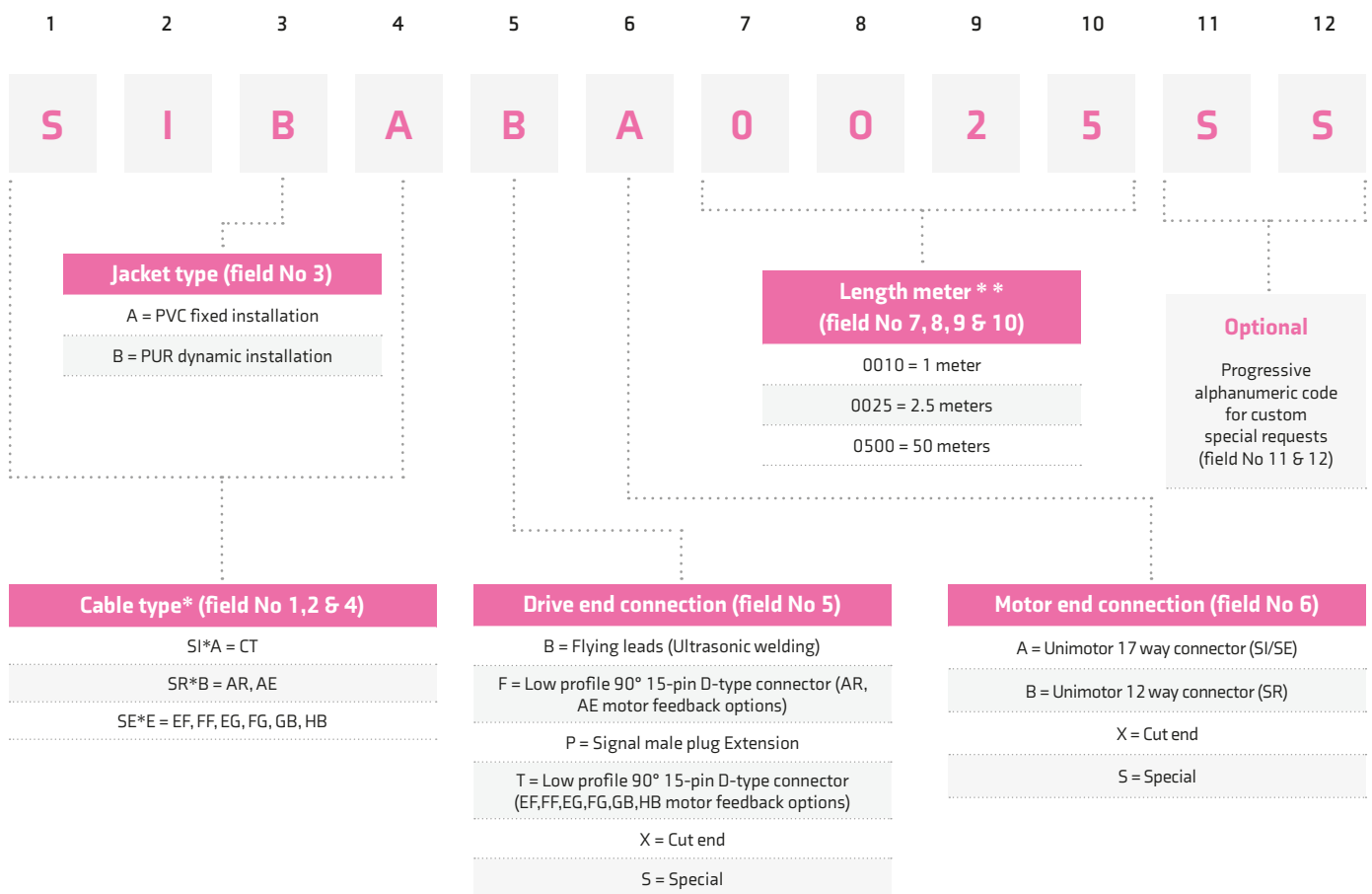

\* Selected based on the "Feedback Device" field of the motor product code key, see page 38.

e.g. 067UDB300BACRA would require a SIBAF A0050 cable part number.

\*\* Cable length always rounded up to the next half meter; Eg. 2.1 will be changed to a 2.5 meter cable.

Maximum cable length is 50m.



# CABLES AND CONNECTIONS

# HYBRID CABLE

## PRODUCT CODE STRUCTURE

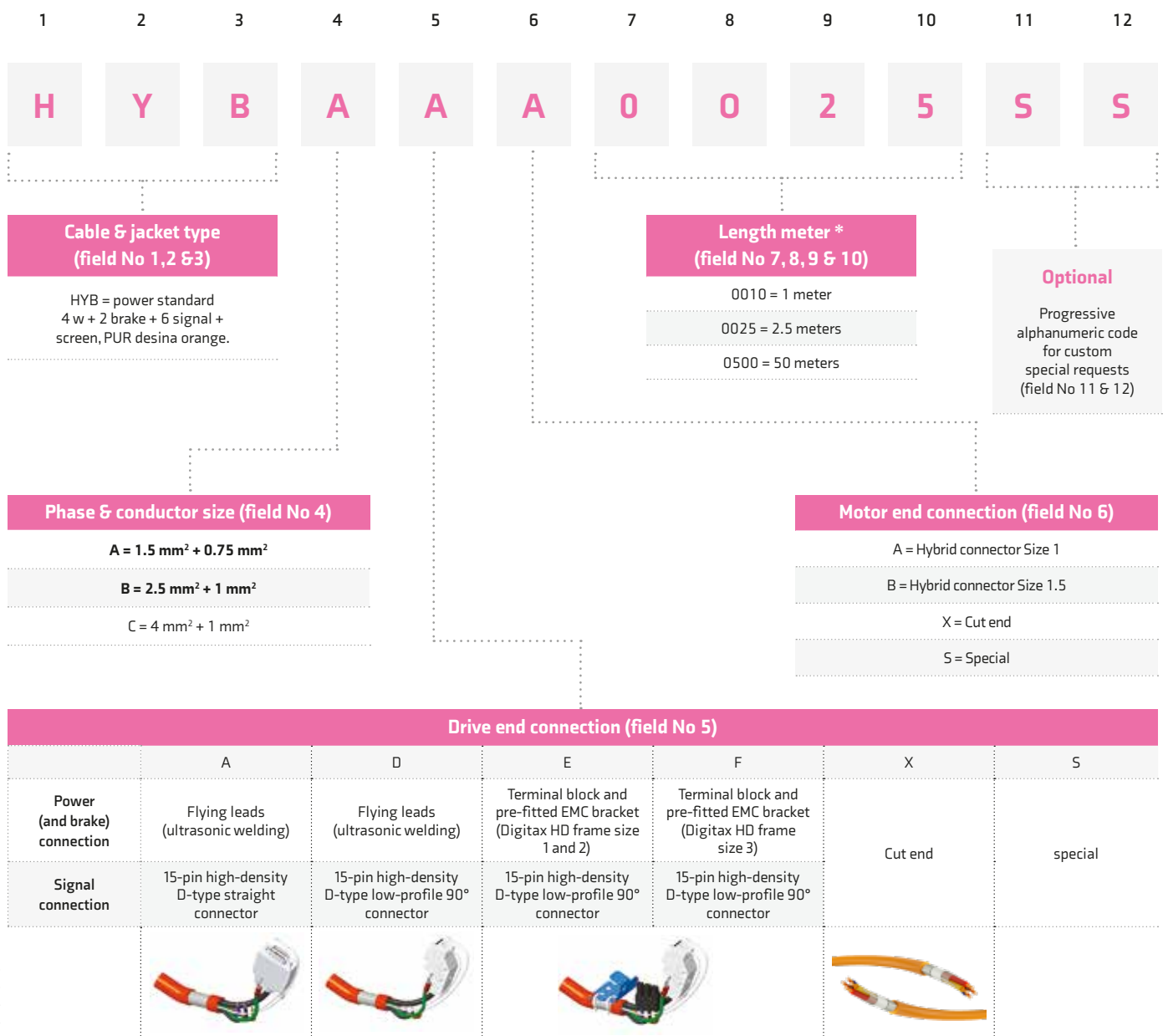

\* Cable length always rounded up to the next half meter; Eg. 2.1 will be changed to a 2.5 meter cable.

Maximum cable length is 50m





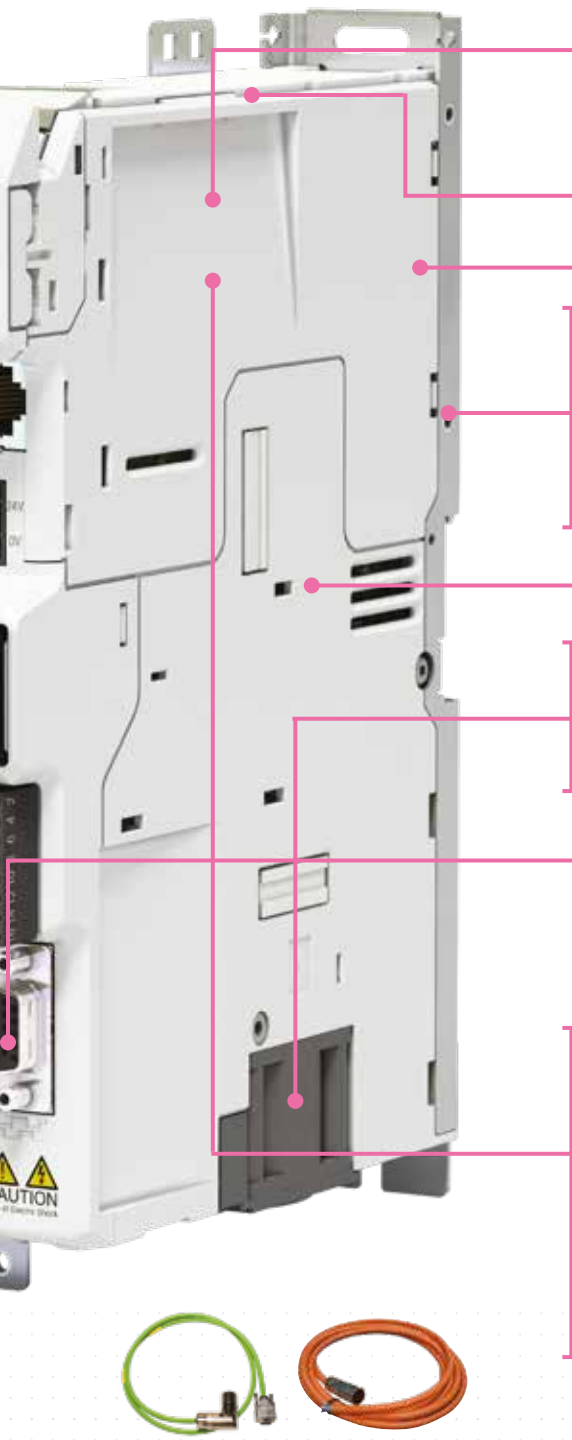

# KITS AND ACCESSORIES ORDERING GUIDE

Multi-axis Kit		
Product code	Accessory	Description
9500-1047		Multi-axis Kit (standard – without SI-Option Mounting Kit fitted)
9500-1048		Multi-axis Kit (with SI-Option Mounting Kit fitted)
DC bus accessories		
3470-0145		External Cable Grommet Kit up to 6mm <sup>2</sup>
9500-1050		External DC Cable connection Kit up to 16mm <sup>2</sup>
Communications and Diagnostics		
4500-0096		USB to EIA485 Communications Converter Cable
82700000020300		KI-Compact 485 Adaptor
82700000020400		KI-Compact Display
82400000019600		Remote Keypad RTC





**General accessories**

Product code	Accessory	Description
4401-0236		Input Line Choke
3470-0158		Frame 1 Rear Ultraflow™ Vent Kit
3470-0181		Frame 2/3 Rear Ultraflow™ Vent Kit
3470-0185		Retrofit Kit – Epsilon 202-206
3470-0184		Retrofit Kit – Epsilon 209-216
3470-0182		Retrofit Kit – Digitax ST/SP0
3470-0183		Retrofit Kit – M'Ax
9500-1055		SI-Option Mounting Kit
9500-1053		Fan Replacement Kit (frame 1 and 2)
9500-1054		Fan Replacement Kit (frame 3)
82700000020200		Encoder breakout kit

**Drive – Mountable Brake Resistor**

9500-1049		Compact Brake Resistor Kit – 50 W, 70 Ω
-----------	---	---

**External Brake Resistor**

1220-2201		External Brake Resistor – DBR 100 W, 20 Ω
1220-2401		External Brake Resistor – DBR 100 W, 40 Ω
1220-2801		External Brake Resistor – DBR 100 W, 80 Ω

Drive and motor cables available  
Refer to pages 39 - 41

# KITS AND ACCESSORIES ORDERING GUIDE (CONTINUED)

## EMC Filters

Voltage	Model (M75X-...)	Phases	Product code
200 V	1200022	1	
	1200040	1	4200-3503
	1200065	1	
	2200090	1	4200-5033
	2200120	1	
	3200160	1	4200-6034
	1200022	3	4200-8744
	1200040	3	4200-6002
	1200065	3	4200-6001
	2200090	3	4200-5833
	2200120	3	4200-5833
	3200160	3	4200-5833
400 V	01400015 to 01400042	3	4200-8744
	02400060 to 02400105	3	4200-1644
	03400135 to 03400160	3	4200-5833
	* Multi-axis up to 46 A		4200-3233
	* Multi-axis up to 60.2 A		4200-5534
	* Multi-axis up to 82.2 A		4200-7534
	* Multi-axis up to 109.5 A		4200-0035







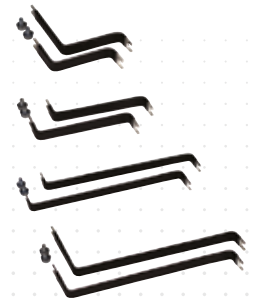







\* EMC filter ratings provided at maximum continuous current at 40 °C (104 °F). Please refer to the installation and Technical Guide.



Description	Product code
DC bus conn. kit - Unidrive M fr03 (panel mount)	3470-0146
DC bus conn. kit - Unidrive M fr03 (through mount)	3470-0147
DC bus conn. kit - Unidrive M fr06 (panel mount)	3470-0148
DC bus conn. kit - Unidrive M fr06 (through mount)	3470-0149



## System Integration Option Modules

Option		Product code	Option		Product code
MCI200		82400000017000	SI-DeviceNet		82400000017700
MCI210		82400000016700	SI-POWERLINK		82400000021600
SI-Apps Compact		82400000020700	SI-Universal Encoder		82400000018300
MiS250		82700000021500	SI-Encoder		82400000018100
SI-Ethernet		82400000017900	SI-I/O		82400000017800
SI-PROFINET RT		82500000018200	SI-EtherCAT		82400000018000
SI-PROFIBUS		82400000017500	PTI210		82400000021400
SI-CANopen		82400000017600			

## In the box for each Digitax HD M75x

Description	Product code	M750 Ethernet	M751 Base	M753 EtherCAT	M754 MCI	M75C CapShare
KI-Compact Display	82700000020400	Yes	No	Yes	Yes	N/A
SI-Option Mounting Kit	9500-1055	No	Yes	No	No	N/A
Removable cable screen bracket	-	Yes	Yes	Yes	Yes	N/A
Brake Connector	-	Yes	Yes	Yes	Yes	N/A
Power Input Connector	-	Yes	Yes	Yes	Yes	N/A
24 Vdc Supply Input Connector	-	Yes	Yes	Yes	Yes	Yes
I/O Connector	-	Yes	Yes	Yes	Yes	N/A
Motor Connector	-	Yes	Yes	Yes	Yes	N/A
M4 x 8 Screws (Motor earth, Input earth and cable screen bracket)	-	Yes	Yes	Yes	Yes	N/A

# DIGITAX HD

# RATING AND DIMENSIONS

## 200 V Single Phase

Frame Size W x D x H mm (in)	Frame Size 01 40 x 174 x 233 (1.57 x 6.85 x 9.17)			Frame Size 02 40 x 174 x 278 (1.57 x 6.85 x 10.94)		Frame Size 03 40 x 174 x 328 (1.57 x 6.85 x 12.91)	
Line Supply	Single Phase AC 200 V...240 V (± 10%) @ 45...66 Hz						
	M75X-...	01200022	01200040	01200065	02200090	02200120	03200160
<b>Input</b>							
Max Power (kW)	1.2			2.6		3.8	
<b>Output Servo (RFC-5)</b>							
Rated Current (A)	1.1	2.2	3.5	5.6	7.5	10.8	
Max Peak Current (A)	6.6	12	19.5	27	36	48	
<b>Output AC Induction (RFC-A)</b>							
Max Continuous Current (A)	1.1	2.2	3.5	5.6	7.5	10.8	
Open Loop Peak Current (A)	3.3	6	9.8	13.5	18	24	
Closed Loop Peak Current (A)	6.6	12	19.5	27	36	48	
Motor Power at 230 V (kW)	0.18	0.37	0.75	1.1	1.5	2.2	
Motor Power at 230 V (hp)	0.25	0.5	1.0	1.5	2.0	3.0	
<b>Overload</b>							
Closed-loop Overload	Maximum closed loop peak current for 0.25 s						
Open-loop Overload	Maximum open loop peak current for 8 s						

## 200 V Three Phase

Frame Size W x D x H mm (in)	Frame Size 01 40 x 174 x 233 (1.57 x 6.85 x 9.17)			Frame Size 02 40 x 174 x 278 (1.57 x 6.85 x 10.94)			Frame Size 03 40 x 174 x 328 (1.57 x 6.85 x 12.91)		
Line supply	Three Phase AC 200 V...240 V (± 10%) @ 45...66 Hz								
	M75X-...	01200022	01200040	01200065	02200090	02200120		03200160	
<b>Input</b>									
Max Power (kW)	4 / 5.2*			5.3 / 6.9*			6.3/10*		
<b>Output Servo (RFC-S)</b>									
Rated Current (A)	2.2	4	6.5	9	12	16			
Max Peak Current (A)	6.6	12	19.5	27	36	48			
<b>Output AC Induction (RFC-A)</b>									
Max Continuous Current (A)	2.2	4	6.5	9	12	16			
Open Loop Peak Current (A)	3.3	6	9.8	13.5	18	24			
Closed Loop Peak Current (A)	6.6	12	19.5	27	36	48			
Motor Power at 230 V (kW)	0.37	0.75	1.1	2.2	2.2	4.0			
Motor Power at 230 V (hp)	0.5	1.0	1.5	2.0	3.0	5.0			
<b>Overload</b>									
Closed-loop Overload	300 % for 0.25 s or 200 % for 4 s								
Open-loop Overload	150 % for 8 s								

## 400 V Three Phase

Frame Size W x D x H mm (in)	Frame Size 01 40 x 174 x 233 (1.57 x 6.85 x 9.17)			Frame Size 02 40 x 174 x 278 (1.57 x 6.85 x 10.94)			Frame Size 03 40 x 174 x 328 (1.57 x 6.85 x 12.91)		
Line supply	Three Phase AC 380 V...480 V (± 10%) @ 45...66 Hz								
	M75X-...	01400015	01400030	01400042	02400060	02400080	02400105	03400135	03400160
<b>Input</b>									
Max Power (kW)	6.5 / 8.5*			8.7 / 11.4*			10 / 13*		
<b>Output Servo (RFC-S)</b>									
Rated Current (A)	1.5	3	4.2	6	8	10.5	13.5	16	
Max Peak Current (A)	4.5	9	12.6	18	24	31.5	40.5	48	
<b>Output AC Induction (RFC-A)</b>									
Max Continuous Current (A)	1.5	3	4.2	6	8	10.5	13.5	16	
Open Loop Peak Current (A)	2.3	4.5	6.3	9	12	15.8	20.3	24	
Closed Loop Peak Current (A)	4.5	9	12.6	18	24	31.5	40.5	48	
Motor Power at 400 V (kW)	0.37	0.75	1.5	2.2	3.0	4.0	5.5	5.5	
Motor Power at 400 V (hp)	0.75	1.5	2.0	3.0	5.0	5.0	7.5	10.0	
<b>Overload</b>									
Closed-loop Overload	300 % for 0.25 s or 200 % for 4 s								
Open-loop Overload	150 % for 8 s								

\* External AC line reactor required. Please refer to the installation and technical guide.

# DIMENSIONS

## Frame 1

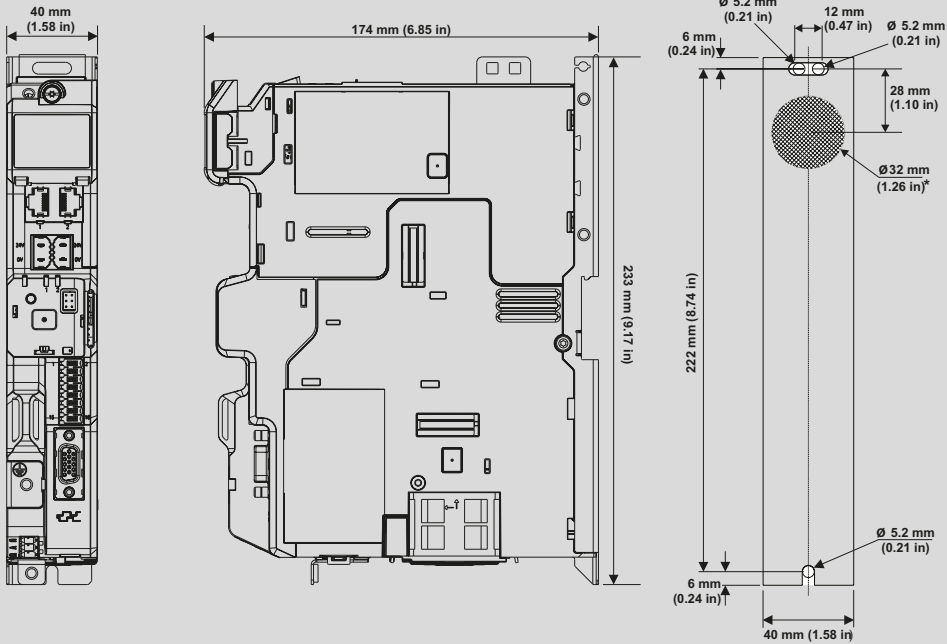

## Frame 2

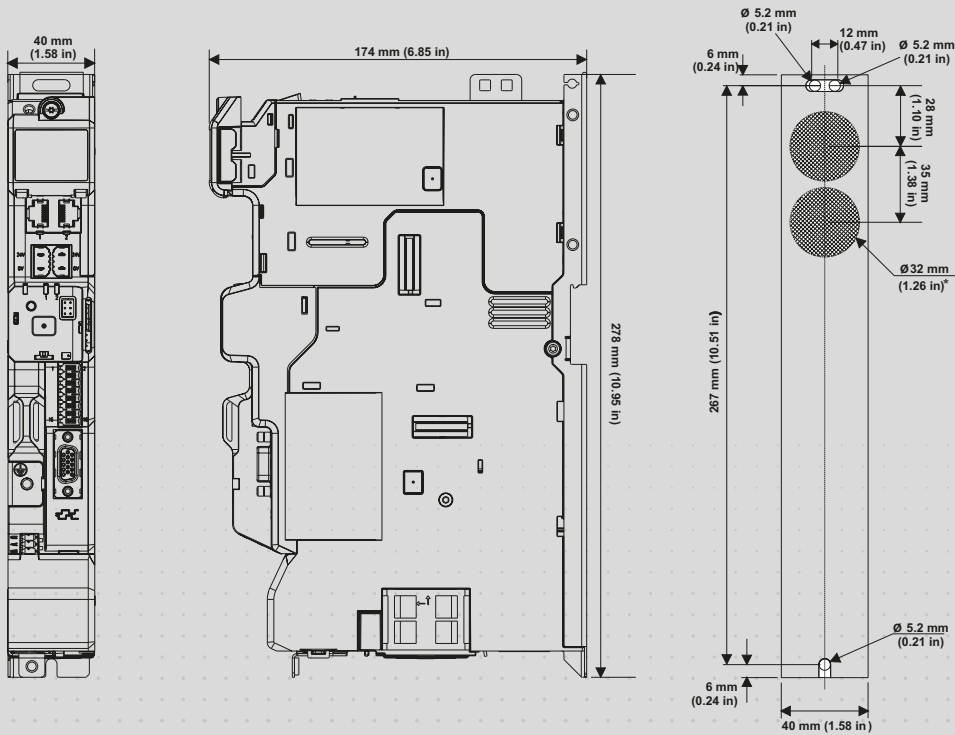



# Frame 3

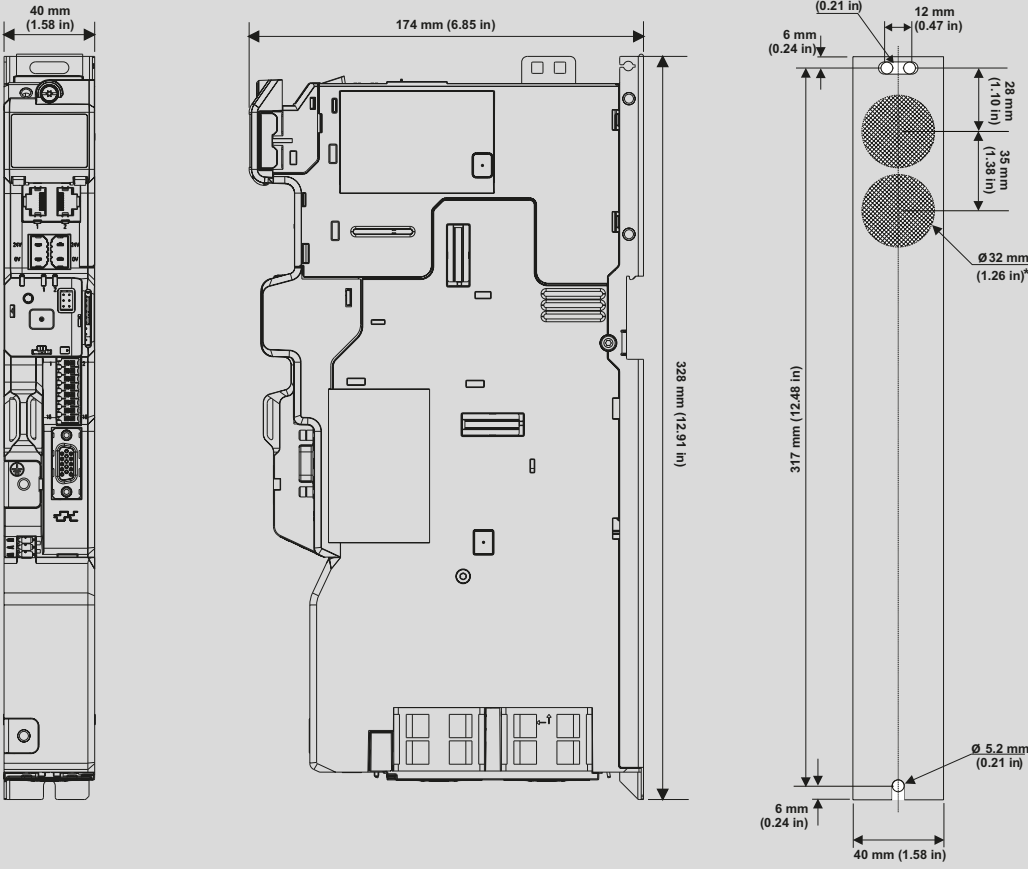

- Notes:**
- Additional space above and below the drive may be required for cable routing.
  - Option module frame adds 22mm width.
  - Alternative screw mounting options available. Please refer to the Installation Guide.

# UNIMOTOR HD

# RATINGS AND DIMENSIONS

## FRAME SIZE 060

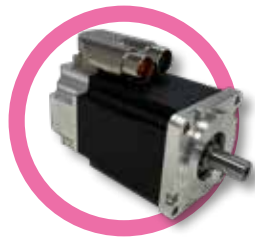

Motor frame size (mm)	060ED		
Voltage (Vrms)	200-240		
Frame length	A	B	C
Continuous stall torque (Nm)	0.64	1.28	1.92
Peak torque (Nm)	2.24	4.48	6.72
Standard inertia (kg cm <sup>2</sup> )	0.18	0.33	0.48
Standard motor weight (kg)	1.6	2.0	2.2
Number of poles	10	10	10
Speed 6000 (rpm)	Kt (Nm/A) = 0.47 Ke (V/krpm) = 28.5		
Rated torque (Nm)	0.64	1.28	1.92
Stall current (A)	1.36	2.72	4.09
Rated power (kW)	0.4	0.8	1.2
R (ph-ph) (Ohms)	5.15	1.90	1.15
L (ph-ph) (mH)	23.8	11.1	7.3
Recommended power conn' size	Y-TEC		

Motor frame size (mm)	060UD		
Voltage (Vrms)	380-480		
Frame length	A	B	C
Continuous stall torque (Nm)	0.64	1.28	1.92
Peak torque (Nm)	2.24	4.48	6.72
Standard inertia (kg cm <sup>2</sup> )	0.18	0.33	0.48
Standard motor weight (kg)	1.6	2.0	2.2
Number of poles	10	10	10
Speed 6000 (rpm)	Kt (Nm/A) = 0.8 Ke (V/krpm) = 49		
Rated torque (Nm)	0.64	1.28	1.92
Stall current (A)	0.8	1.6	2.4
Rated power (kW)	0.4	0.8	1.2
R (ph-ph) (Ohms)	24.00	10.10	5.90
L (ph-ph) (mH)	91.5	46.8	32.6
Recommended power conn' size	Y-TEC		

All data subject to +/-10% tolerance  
 Stall torque, rated torque and power relate to maximum continuous operation tested in a 20°C ambient at 12 kHz drive switching frequency  
 All other figures relate to a 20°C motor temperature.  
 Maximum intermittent winding temperature is 140°C

	Motor Dimension														
	Feedback CT				Flange thickness	Register length	Register diameter	Overall height	Flange square	Fixing hole diameter	Fixing hole PCD	Motor housing	Mounting bolts		
	Unbraked length	Braked length												LA (± 0.5)	T (± 0.1)
	LB (± 0.9)	LC (± 1.0)	LC (± 1.0)	LC (± 1.0)											
060A	82.5	66.5	119.5	103.5	7.5	3	50	80	60	5.5	70	60	M5	mm	
060B	102.5	86.5	139.5	123.5											
060C	122.5	106.5	159.5	143.5											



Shaft Dimension									
	Shaft diameter	Shaft length	Key height	Key length	Key to shaft end	Key width	Tapped hole thread size	Tapped hole depth	
	D(j6)	E	GA	GF	G	F(h9)	I	J(±1)	
14.0 Std	14	30	16	22	1.5	5	M5 x 0.8	10	mm

Feedback EG, FG		
	Unbraked length	Braked length
	LB (± 0.9)	LB (± 0.9)
060A	100	137
060B	120	157
060C	140	177

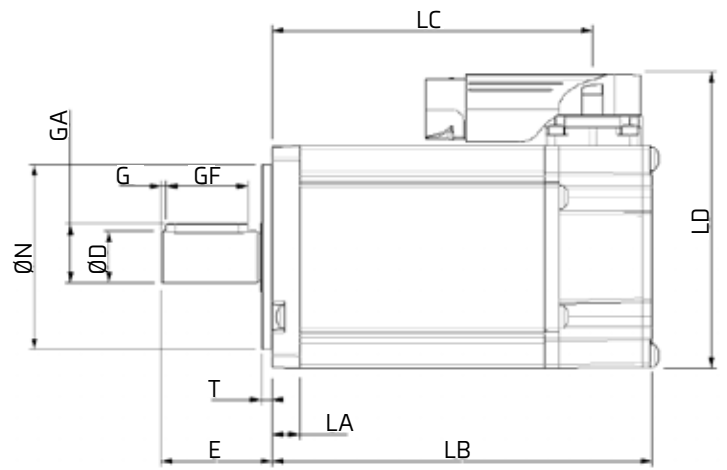
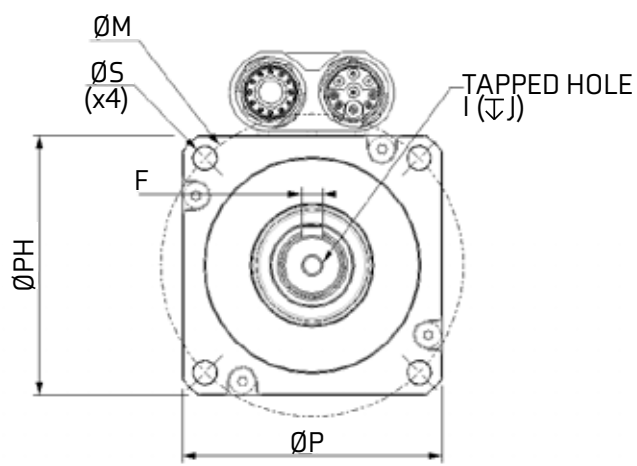

# FRAME SIZE 067



Motor frame size (mm)		067ED			
Voltage (Vrms)		200-240			
Frame length		A	B	C	D
Continuous stall torque (Nm)		1.44	2.55	3.70	4.72
Peak torque (Nm)		4.35	7.65	11.10	14.60
Standard inertia (kg cm <sup>2</sup> )		0.30	0.53	0.75	0.94
Winding thermal time constant (sec)		54	61	65	68
Standard motor weight (kg)		1.96	2.56	3.16	3.80
Number of poles		10	10	10	10
Speed 3000 (rpm)	$K_t$ (Nm/A) = $K_e$ (V/krpm) =	0.93 57			
Rated torque (Nm)		1.40	2.45	3.50	4.60
Stall current (A)		1.55	2.74	3.98	5.08
Rated power (kW)		0.44	0.77	1.10	1.45
R (ph-ph) (Ohms)		15.16	5.85	3.33	2.32
L (ph-ph) (mH)		46.7	20.6	12.7	10.6
Recommended power conn' size		1	1	1	1
Speed 6000 (rpm)	$K_t$ (Nm/A) = $K_e$ (V/krpm) =	0.47 28.5			
Rated torque (Nm)		1.3	2.2	3.1	4.0
Stall current (A)		3.06	5.43	7.87	10.04
Rated power (kW)		0.82	1.38	1.95	2.51
R (ph-ph) (Ohms)		3.79	1.46	0.76	0.54
L (ph-ph) (mH)		11.7	5.2	3.6	2.03
Recommended power conn' size		1	1	1	1

Motor frame size (mm)		067UD			
Voltage (Vrms)		380-480			
Frame length		A	B	C	D
Continuous stall torque (Nm)		1.44	2.55	3.70	4.72
Peak torque (Nm)		4.35	7.65	11.10	14.60
Standard inertia (kg cm <sup>2</sup> )		0.30	0.53	0.75	0.94
Winding thermal time constant (sec)		54	61	65	68
Standard motor weight (kg)		1.96	2.56	3.16	3.80
Number of poles		10	10	10	10
Speed 3000 (rpm)	$K_t$ (Nm/A) = $K_e$ (V/krpm) =	0.8 49			
Rated torque (Nm)		1.40	2.45	3.50	4.60
Stall current (A)		1.80	1.59	2.31	2.95
Rated power (kW)		0.44	0.77	1.10	1.45
R (ph-ph) (Ohms)		11.69	18.55	10.70	6.42
L (ph-ph) (mH)		35.2	65.6	40.8	31.2
Recommended power conn' size		1	1	1	1
Speed 6000 (rpm)	$K_t$ (Nm/A) = $K_e$ (V/krpm) =	0.8 49			
Rated torque (Nm)		1.3	2.2	3.1	4.0
Stall current (A)		1.80	3.19	4.63	5.90
Rated power (kW)		0.82	1.38	1.95	2.51
R (ph-ph) (Ohms)		11.69	4.64	2.73	1.60
L (ph-ph) (mH)		35.2	16.4	10.2	7.8
Recommended power conn' size		1	1	1	1

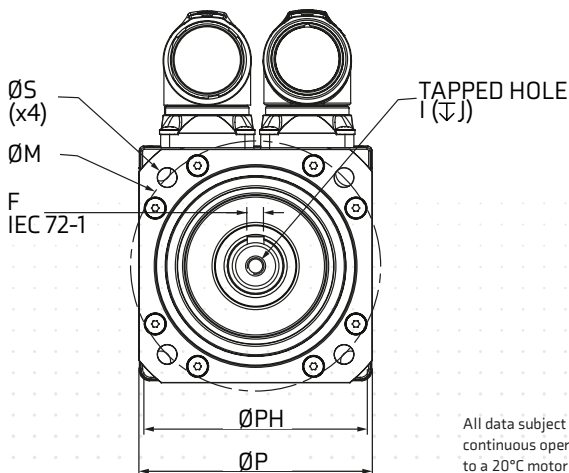

All data subject to +/-10% tolerance. Stall torque, rated torque and power relate to maximum continuous operation tested in a 20°C ambient at 12kHz drive switching frequency. All other figures relate to a 20°C motor temperature. Maximum intermittent winding temperature is 140°C

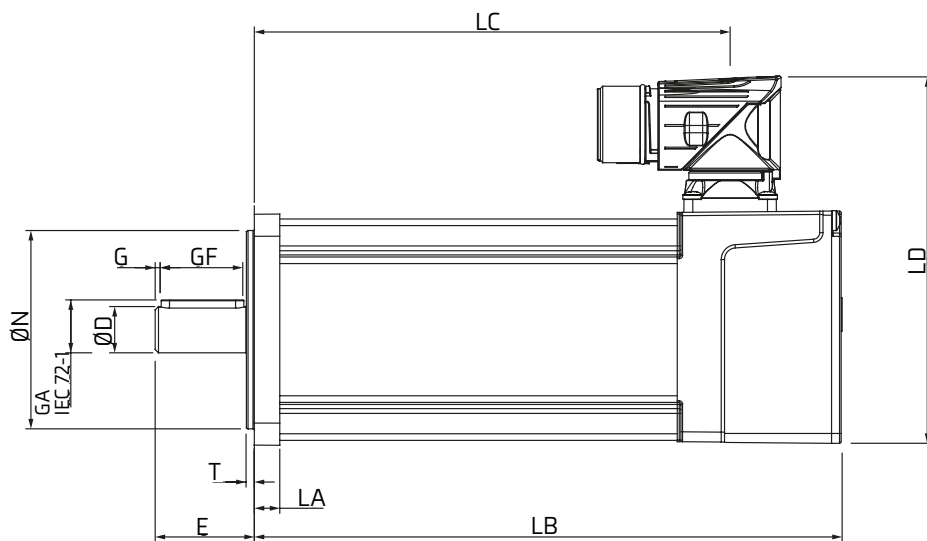

Motor Dimension															
	Feedback AR, CR, EM, FM, EG, FG				Flange thickness	Register length	Register diameter	Overall height	Flange square	Fixing hole diameter	Fixing hole PCD	Motor housing	Mounting bolts		
	Unbraked length	Braked length													
	LB (± 0.9)	LC (± 1.0)	LC (± 1.0)	LC (± 1.0)	LA (± 0.5)	T (± 0.1)	N (j6)	LD (± 0.3)	P (± 0.3)	S (H14)	M (± 0.5)	PH (± 0.5)			
067A	142.9	109	177.9	144	7.7	2.5	60	111.5	70	5.8	75	67	M5	mm	
067B	172.9	139	207.9	174											
067C	202.9	169	237.9	204											
067D	232.9	199	267.9	234											

Shaft Dimension								
	Shaft diameter	Shaft length	Key height	Key length	Key to shaft end	Key width	Tapped hole thread size	Tapped hole depth
	D(j6)	E	GA	GF	G	F(h9)	I	J(±1)
14.0 Std	14	30	16	25	1.5	5	M5 x 0.8	13.5 mm

19mm shaft and 90mm flange options are available. Refer to factory for more information.

# FRAME SIZE 089



Motor frame size (mm)		089ED			
Voltage (Vrms)		200-240			
Frame length		A	B	C	D
Continuous stall torque (Nm)		3.2	5.5	8.0	10.3
Peak torque (Nm)		9.6	16.5	24.0	30.9
Standard inertia (kg cm <sup>2</sup> )		0.87	1.61	2.34	3.20
Winding thermal time constant (sec)		85	93	98	103
Standard motor weight (kg)		3.18	4.28	5.38	6.48
Number of poles		10	10	10	10
Speed 3000 (rpm)	Kt (Nm/A) = Ke (V/krpm) =	0.93 57			
Rated torque (Nm)		3.00	4.85	6.90	8.50
Stall current (A)		3.44	5.91	8.60	11.08
Rated power (kW)		0.94	1.52	2.17	2.67
R (ph-ph) (Ohms)		4.1	1.64	0.93	0.45
L (ph-ph) (mH)		25.0	11.8	7.1	13.7
Recommended power conn' size		1	1	1	1
Speed 4000 (rpm)	Kt (Nm/A) = Ke (V/krpm) =	0.47 42.75			
Rated torque (Nm)		◆	4.55	6.35	◆
Stall current (A)		◆	7.86	11.43	◆
Rated power (kW)		◆	1.91	2.66	◆
R (ph-ph) (Ohms)		◆	0.82	0.56	◆
L (ph-ph) (mH)		◆	6	4.3	◆
Recommended power conn' size		◆	1	1	◆
Speed 6000 (rpm)	Kt (Nm/A) = Ke (V/krpm) =	0.47 28.5			
Rated torque (Nm)		2.65	3.80	5.00	◆
Stall current (A)		6.93	11.70	17.02	◆
Rated power (kW)		1.67	2.39	3.14	◆
R (ph-ph) (Ohms)		1.03	0.41	0.24	◆
L (ph-ph) (mH)		6.2	2.96	1.77	◆
Recommended power conn' size		1	1	1	◆

Motor frame size (mm)		089UD			
Voltage (Vrms)		380-480			
Frame length		A	B	C	D
Continuous stall torque (Nm)		3.2	5.5	8.0	10.3
Peak torque (Nm)		9.6	16.5	24.0	31.5
Standard inertia (kg cm <sup>2</sup> )		0.87	1.61	2.34	3.20
Winding thermal time constant (sec)		85	93	98	103
Standard motor weight (kg)		3.18	4.28	5.38	6.48
Number of poles		10	10	10	10
Speed 3000 (rpm)	Kt (Nm/A) = Ke (V/krpm) =	1.6 98			
Rated torque (Nm)		3.00	4.85	6.90	8.50
Stall current (A)		2.00	3.44	5.00	6.44
Rated power (kW)		0.94	1.52	2.17	2.67
R (ph-ph) (Ohms)		10.80	5.18	2.79	1.89
L (ph-ph) (mH)		66.8	36.7	21.7	17.5
Recommended power conn' size		1	1	1	1
Speed 4000 (rpm)	Kt (Nm/A) = Ke (V/krpm) =	1.2 73.5			
Rated torque (Nm)		◆	4.55	6.35	◆
Stall current (A)		◆	4.58	6.67	◆
Rated power (kW)		◆	1.91	2.66	◆
R (ph-ph) (Ohms)		◆	2.60	1.80	◆
L (ph-ph) (mH)		◆	18.8	13.4	◆
Recommended power conn' size		◆	1	1	◆
Speed 6000 (rpm)	Kt (Nm/A) = Ke (V/krpm) =	0.8 49			
Rated torque (Nm)		2.65	3.80	5.00	◆
Stall current (A)		4.00	6.88	10.00	◆
Rated power (kW)		1.67	2.39	3.14	◆
R (ph-ph) (Ohms)		2.70	1.30	0.67	◆
L (ph-ph) (mH)		16.7	9.2	5.4	◆
Recommended power conn' size		1	1	1	◆

◆ Not available

All data subject to +/-10% tolerance. Stall torque, rated torque and power relate to maximum continuous operation tested in a 20°C ambient at 12kHz drive switching frequency. All other figures relate to a 20°C motor temperature. Maximum intermittent winding temperature is 140°C

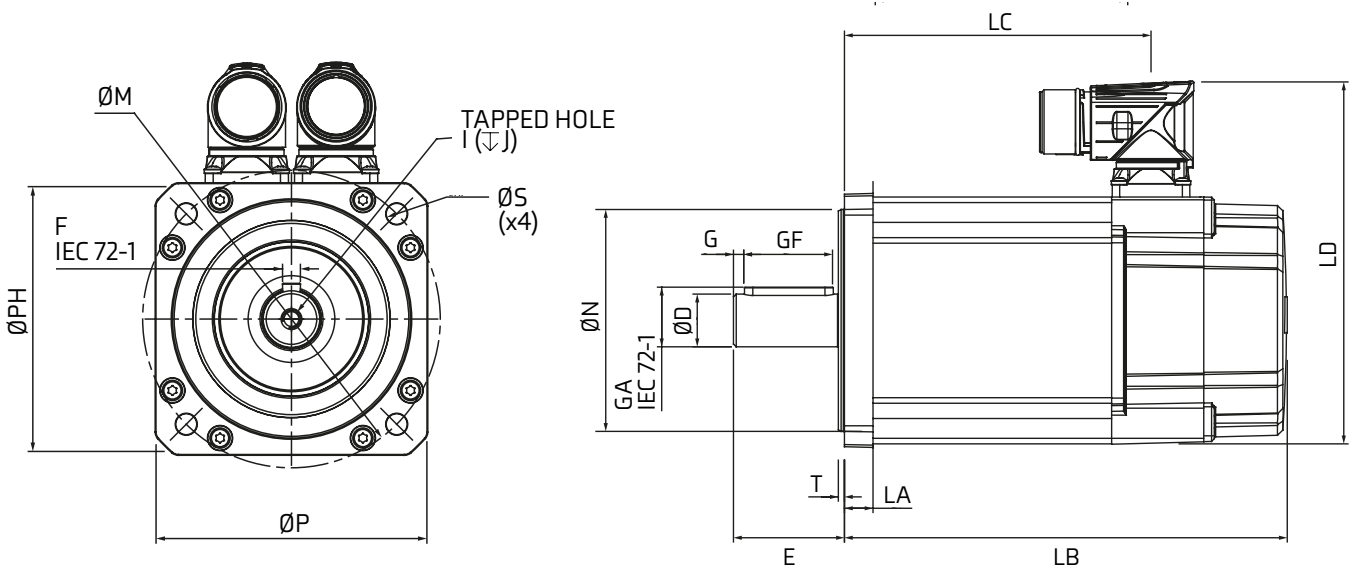

Motor Dimension														
Feedback EC, FC, EF, FF				Flange thickness	Register length	Register diameter	Overall height	Flange square	Fixing hole diameter	Fixing hole PCO	Motor housing	Mounting bolts		
Unbraked length		Braked length												
	LB (±0.9)	LC (±1.0)	LC (±1.0)	LC (±1.0)	LA (±0.5)	T (±0.1)	N (j6)	LD (±0.3)	P (±0.3)	S (H14)	M (±0.5)	PH (±0.5)		
089A	147.8	110.5	187.9	150.6	10.3	2.2	80	130.5	91	7	100	89	M6	mm
089B	177.8	140.5	217.9	180.6										
089C	207.8	170.5	247.9	210.6										
089D	237.8	200.5	277.9	240.6										

Shaft Dimension									
	Shaft diameter	Shaft length	Key height	Key length	Key to shaft end	Key width	Tapped hole thread size	Tapped hole depth	
	D(j6)	E	GA	GF	G	F(h9)	I	J(±1)	
19.0 Std	19	40	21.5	32	3.7	6	M6 x 1	17	mm

24mm shaft and 115mm flange options are available. Refer to factory for more information.

	Feedback CA, GB, HB		Feedback AE		
	Unbraked length	Braked length	Unbraked length	Braked length	
	LB (±0.9)	LB (±0.9)	LB (±0.9)	LB (±0.9)	
089A	160.8	200.9	137.8	177.9	mm
089B	190.8	230.9	167.8	207.9	
089C	220.8	260.9	197.8	237.9	
089D	250.8	290.9	227.8	267.9	

# FRAME SIZE 115

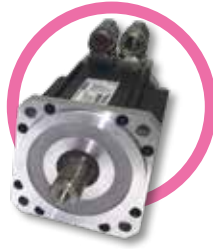

Motor frame size (mm)		115ED			
Voltage (Vrms)		200-240			
Frame length		A	B	C	D
Continuous stall torque (Nm)		5.8	10.2	14.6	18.8
Peak torque (Nm)		17.4	30.6	43.8	56.4
Standard inertia (kg cm <sup>2</sup> )		2.40	4.41	6.39	8.38
Winding thermal time constant (sec)		161	164	168	175
Standard motor weight (kg)		5.20	6.95	8.72	10.49
Number of poles		10	10	10	10
Speed 2000 (rpm)	Kt (Nm/A) = Ke (V/krpm) =			1.4 85.5	
Rated torque (Nm)		◆	◆	11.9	15.6
Stall current (A)		◆	◆	10.43	13.43
Rated power (kW)		◆	◆	2.49	3.27
R (ph-ph) (Ohms)		◆	◆	0.77	0.61
L (ph-ph) (mH)		◆	◆	7.9	6.6
Recommended power conn' size		◆	◆	1	1
Speed 3000 (rpm)	Kt (Nm/A) = Ke (V/krpm) =			0.93 57	
Rated torque (Nm)		4.8	7.7	10.5	◆
Stall current (A)		6.24	10.97	15.70	◆
Rated power (kW)		1.51	2.42	3.30	◆
R (ph-ph) (Ohms)		1.59	0.58	0.39	◆
L (ph-ph) (mH)		12.8	5.4	4.0	◆
Recommended power conn' size		1	1	1	◆
Speed 4000 (rpm)	Kt (Nm/A) = Ke (V/krpm) =			0.7 42.75	
Rated torque (Nm)		◆	◆	8.7	◆
Stall current (A)		◆	◆	20.86	◆
Rated power (kW)		◆	◆	3.64	◆
R (ph-ph) (Ohms)		◆	◆	0.12	◆
L (ph-ph) (mH)		◆	◆	4	◆
Recommended power conn' size		◆	◆	1	◆
Speed 6000 (rpm)	Kt (Nm/A) = Ke (V/krpm) =			0.47 28.5	
Rated torque (Nm)		3.6	4.8	◆	◆
Stall current (A)		12.34	21.70	◆	◆
Rated power (kW)		2.26	3.02	◆	◆
R (ph-ph) (Ohms)		0.40	0.09	◆	◆
L (ph-ph) (mH)		3.2	2.8	◆	◆
Recommended power conn' size		1	1	◆	◆

Motor frame size (mm)		115UD			
Voltage (Vrms)		380-480			
Frame length		A	B	C	D
Continuous stall torque (Nm)		5.8	10.2	14.6	18.8
Peak torque (Nm)		17.4	30.6	43.8	56.4
Standard inertia (kg cm <sup>2</sup> )		2.40	4.41	6.39	8.38
Winding thermal time constant (sec)		161	164	168	175
Standard motor weight (kg)		5.20	6.95	8.72	10.49
Number of poles		10	10	10	10
Speed 2000 (rpm)	Kt (Nm/A) = Ke (V/krpm) =			2.4 147	
Rated torque (Nm)		◆	◆	11.9	15.6
Stall current (A)		◆	◆	6.08	7.83
Rated power (kW)		◆	◆	2.49	3.27
R (ph-ph) (Ohms)		◆	◆	2.41	1.80
L (ph-ph) (mH)		◆	◆	24.7	19.5
Recommended power conn' size		◆	◆	1	1
Speed 3000 (rpm)	Kt (Nm/A) = Ke (V/krpm) =			1.6 98	
Rated torque (Nm)		4.8	7.7	10.5	13.6
Stall current (A)		3.03	6.38	9.13	11.75
Rated power (kW)		1.51	2.42	3.30	4.27
R (ph-ph) (Ohms)		5.00	1.90	1.21	0.78
L (ph-ph) (mH)		40.3	18.0	12.7	8.7
Recommended power conn' size		1	1	1	1
Speed 4000 (rpm)	Kt (Nm/A) = Ke (V/krpm) =			1.2 73.5	
Rated torque (Nm)		◆	◆	8.7	◆
Stall current (A)		◆	◆	12.1	◆
Rated power (kW)		◆	◆	3.64	◆
R (ph-ph) (Ohms)		◆	◆	0.6	◆
L (ph-ph) (mH)		◆	◆	6.6	◆
Recommended power conn' size		◆	◆	1	◆
Speed 6000 (rpm)	Kt (Nm/A) = Ke (V/krpm) =			0.8 49	
Rated torque (Nm)		3.6	4.8	◆	◆
Stall current (A)		7.25	12.75	◆	◆
Rated power (kW)		2.26	3.02	◆	◆
R (ph-ph) (Ohms)		1.25	0.47	◆	◆
L (ph-ph) (mH)		10.1	4.5	◆	◆
Recommended power conn' size		1	1	◆	◆

◆ Not available

All data subject to +/-10% tolerance. Stall torque, rated torque and power relate to maximum continuous operation tested in a 20°C ambient at 12kHz drive switching frequency. All other figures relate to a 20°C motor temperature. Maximum intermittent winding temperature is 140°C



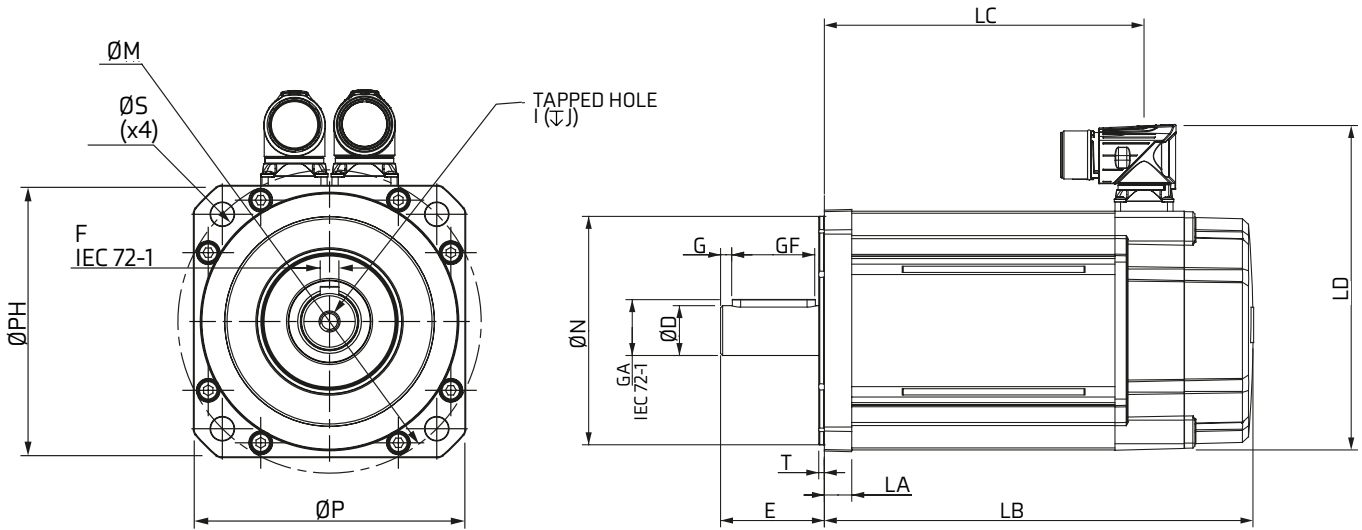

Motor Dimension															
Feedback EC, FC, EF, FF					Flange thickness	Register length	Register diameter	Overall height	Flange square	Fixing hole diameter	Fixing hole PCD	Motor housing	Mounting bolts		
Unbraked length		Braked length													
	LB (± 0.9)	LC (± 1.0)	LC (± 1.0)	LC (± 1.0)	LA (± 0.5)	T (± 0.1)	N (j6)	LD (± 0.3)	P (± 0.3)	S (H14)	M (± 0.5)	PH (± 0.5)			
115A	163.8	124	200.9	161.1	13.2	2.7	110	156.5	116	10	130	115	M8	mm	
115B	193.8	154	230.9	191.1											
115C	223.8	184	260.9	221.1											
115D	253.8	214	290.9	251.1											

Shaft Dimension									
	Shaft diameter	Shaft length	Key height	Key length	Key to shaft end	Key width	Tapped hole thread size	Tapped hole depth	
	D (j6)	E	GA	GF	G	F (h9)	I	J (± 1)	
24.0 Std	24	50	27	40	5.3	8	M8 x 1.25	20	mm

28mm shaft and 145mm flange options are available. Refer to factory for more information.

	Feedback CA, GB, HB		Feedback AE		mm
	Unbraked length	Braked length	Unbraked length	Braked length	
	LB (± 0.9)	LB (± 0.9)	LB (± 0.9)	LB (± 0.9)	
115A	176.8	213.9	153.8	190.9	mm
115B	206.8	243.9	183.8	220.9	
115C	236.8	273.9	213.8	250.9	
115D	266.8	303.9	243.8	280.9	

# FRAME SIZE 142



Motor frame size (mm)		142ED				
Voltage (Vrms)		200-240				
Frame length		A	B	C	D	E
Continuous stall torque (Nm)		10.1	17.4	25.0	31.5	38.0
Peak torque (Nm)		30.3	52.2	75.0	94.5	114.0
Standard inertia (kg cm <sup>2</sup> )		5.6	11.0	17.0	22.1	27.2
Winding thermal time constant (sec)		235	240	245	251	256
Standard motor weight (kg)		7.40	10.10	12.74	15.39	18.04
Number of poles		10	10	10	10	10
Speed 2000 (rpm)	Kt (Nm/A) = Ke (V/krpm) =	1.4 85.5				
Rated torque (Nm)		8.6	15.3	21.4	◆	◆
Stall current (A)		7.21	12.43	17.86	◆	◆
Rated power (kW)		1.80	3.20	4.48	◆	◆
R (ph-ph) (Ohms)		0.85	0.34	0.24	◆	◆
L (ph-ph) (mH)		14.3	5.9	3.7	◆	◆
Recommended power conn' size		1	1	1.5	◆	◆
Speed 3000 (rpm)	Kt (Nm/A) = Ke (V/krpm) =	0.93 57				
Rated torque (Nm)		8.2	14.0	18.4	20.9	◆
Stall current (A)		10.86	18.71	26.88	33.87	◆
Rated power (kW)		2.58	4.40	5.78	6.57	◆
R (ph-ph) (Ohms)		0.38	0.22	0.12	0.09	◆
L (ph-ph) (mH)		6.3	2.8	1.9	1.6	◆
Recommended power conn' size		1	1.5	1.5	1.5	◆
Speed 4000 (rpm)	Kt (Nm/A) = Ke (V/krpm) =	0.7 42.75				
Rated torque (Nm)		◆	11.7	◆	◆	◆
Stall current (A)		◆	24.86	◆	◆	◆
Rated power (kW)		◆	4.90	◆	◆	◆
R (ph-ph) (Ohms)		◆	0.08	◆	◆	◆
L (ph-ph) (mH)		◆	4.5	◆	◆	◆
Recommended power conn' size		◆	1.5	◆	◆	◆
Speed 6000 (rpm)	Kt (Nm/A) = Ke (V/krpm) =	0.47 28.5				
Rated torque (Nm)		◆	◆	◆	◆	◆
Stall current (A)		◆	◆	◆	◆	◆
Rated power (kW)		◆	◆	◆	◆	◆
R (ph-ph) (Ohms)		◆	◆	◆	◆	◆
L (ph-ph) (mH)		◆	◆	◆	◆	◆
Recommended power conn' size		◆	◆	◆	◆	◆

Motor frame size (mm)		142UD				
Voltage (Vrms)		380-480				
Frame length		A	B	C	D	E
Continuous stall torque (Nm)		10.1	17.4	25.0	31.5	38.0
Peak torque (Nm)		30.3	52.2	75.0	94.5	114.0
Standard inertia (kg cm <sup>2</sup> )		5.6	11.0	17.0	22.1	27.2
Winding thermal time constant (sec)		235	240	245	251	256
Standard motor weight (kg)		7.40	10.10	12.74	15.39	18.04
Number of poles		10	10	10	10	10
Speed 2000 (rpm)	Kt (Nm/A) = Ke (V/krpm) =	2.4 147				
Rated torque (Nm)		8.6	15.3	21.4	◆	◆
Stall current (A)		4.21	7.25	10.42	◆	◆
Rated power (kW)		1.80	3.20	4.48	◆	◆
R (ph-ph) (Ohms)		3.90	1.53	0.79	◆	◆
L (ph-ph) (mH)		46.28	20.97	12.15	◆	◆
Recommended power conn' size		1	1	1	◆	◆
Speed 3000 (rpm)	Kt (Nm/A) = Ke (V/krpm) =	1.6 98				
Rated torque (Nm)		8.2	14.0	18.4	20.9	23.0
Stall current (A)		6.31	10.88	15.63	19.69	23.75
Rated power (kW)		2.58	4.40	5.78	6.57	7.23
R (ph-ph) (Ohms)		1.50	0.63	0.34	0.24	0.18
L (ph-ph) (mH)		18.1	8.6	5.3	3.8	2.9
Recommended power conn' size		1	1	1	1.5	1.5
Speed 4000 (rpm)	Kt (Nm/A) = Ke (V/krpm) =	1.2 74				
Rated torque (Nm)		◆	11.7	◆	14.9	◆
Stall current (A)		◆	14.50	◆	26.25	◆
Rated power (kW)		◆	4.90	◆	6.24	◆
R (ph-ph) (Ohms)		◆	0.36	◆	0.16	◆
L (ph-ph) (mH)		◆	7.1	◆	2.4	◆
Recommended power conn' size		◆	1	◆	1.5	◆
Speed 6000 (rpm)	Kt (Nm/A) = Ke (V/krpm) =	0.8 49				
Rated torque (Nm)		◆	7	◆	◆	◆
Stall current (A)		◆	21.75	◆	◆	◆
Rated power (kW)		◆	4.4	◆	◆	◆
R (ph-ph) (Ohms)		◆	0.17	◆	◆	◆
L (ph-ph) (mH)		◆	3.2	◆	◆	◆
Recommended power conn' size		◆	1.5	◆	◆	◆

◆ Not available

All data subject to +/-10% tolerance. Stall torque, rated torque and power relate to maximum continuous operation tested in a 20°C ambient at 12kHz drive switching frequency. All other figures relate to a 20°C motor temperature. Maximum intermittent winding temperature is 140°C

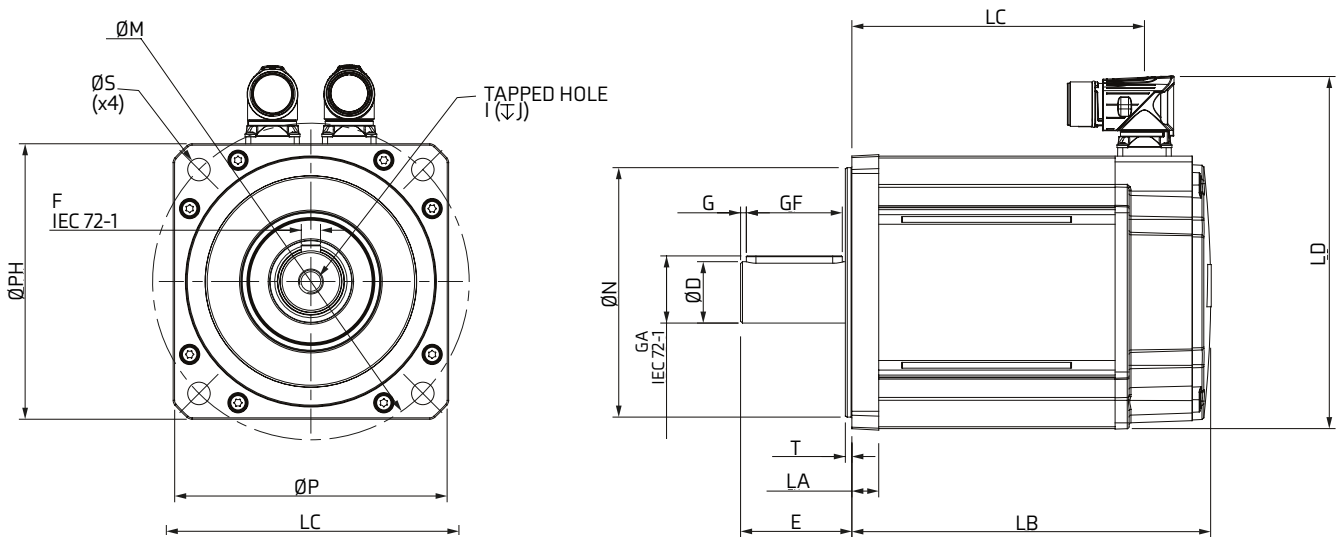

Motor Dimension													
	Unbraked length		Braked length		Flange thickness	Register length	Register diameter	Overall height	Flange square	Fixing hole diameter	Fixing hole PCD	Motor housing	Mounting bolts
	LB (± 0.9)	LC (± 1.0)	LC (± 1.0)	LC (± 1.0)	LA (± 0.5)	T (± 0.1)	N (j6)	LD (± 0.3)	P (± 0.3)	S (H14)	M (± 0.5)	PH (± 0.5)	
142A	157	122.5	222.5	188				183.5					
142B	187	152.5	252.5	218				(Size 1)					
142C	217	182.5	282.5	248	14	3.4	130	204.5	142	12	165	142	M10 mm
142D	247	212.5	312.5	278				(Size 1.5)					
142E	277	242.5	342.5	308									

Shaft Dimension									
	Shaft diameter	Shaft length	Key height	Key length	Key to shaft end	Key width	Tapped hole thread size	Tapped hole depth	
	D(j6)	E	GA	GF	G	F(h9)	I	J(±1)	
32.0 Std	32	58	35	50	3	10	M12 x 1.75	29	mm

24mm shaft and 200mm flange options are available. Refer to factory for more information.

# FRAME SIZE 190

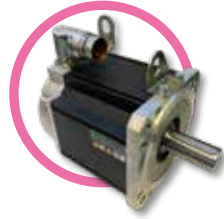

Motor frame size (mm)		190ED					
Voltage (Vrms)		200-240					
Frame length		A	B	C	D	E	F
Continuous stall torque (Nm)		18.5	32.7	52.0	62.0	73.5	85.0
Peak torque (Nm)		55.5	98.10	156	186	220.5	255
Standard inertia (kg cm <sup>2</sup> )		22.0	38.3	54.6	70.9	87.2	103.5
Winding thermal time constant (sec)		286	292	300	308	316	324
Standard motor weight (kg)		14.60	21.20	27.74	34.30	40.90	47.42
Number of poles		10	10	10	10	10	10
Speed 1000 (rpm)	K <sub>t</sub> (Nm/A) = K <sub>e</sub> (V/krpm) =			2.8 171			
Rated torque (Nm)		17.6	◆	49.0	56.5	◆	77.5
Stall current (A)		6.61	◆	18.57	22.14	◆	30.36
Rated power (kW)		1.84	◆	5.13	5.92	◆	8.12
R (ph-ph) (Ohms)		1.23	◆	0.30	0.27	◆	0.15
L (ph-ph) (mH)		34.1	◆	10.0	7.1	◆	4.8
Recommended power conn' size		1.5	◆	1.5	1.5	◆	1.5
Speed 1500 (rpm)	K <sub>t</sub> (Nm/A) = K <sub>e</sub> (V/krpm) =			1.86 114			
Rated torque (Nm)		◆	◆	46.2	◆	◆	◆
Stall current (A)		◆	◆	25.97	◆	◆	◆
Rated power (kW)		◆	◆	7.26	◆	◆	◆
R (ph-ph) (Ohms)		◆	◆	0.11	◆	◆	◆
L (ph-ph) (mH)		◆	◆	3.5	◆	◆	◆
Recommended power conn' size		◆	◆	1.5	◆	◆	◆
Speed 2000 (rpm)	K <sub>t</sub> (Nm/A) = K <sub>e</sub> (V/krpm) =			1.4 85.5			
Rated torque (Nm)		◆	◆	42.5	◆	◆	◆
Stall current (A)		◆	◆	37.14	◆	◆	◆
Rated power (kW)		◆	◆	8.9	◆	◆	◆
R (ph-ph) (Ohms)		◆	◆	0.09	◆	◆	◆
L (ph-ph) (mH)		◆	◆	2.5	◆	◆	◆
Recommended power conn' size		◆	◆	1.5	◆	◆	◆
Speed 3000 (rpm)	K <sub>t</sub> (Nm/A) = K <sub>e</sub> (V/krpm) =			0.93 57			
Rated torque (Nm)		15.5	25.0	32.8	◆	◆	◆
Stall current (A)		19.89	35.16	55.91	◆	◆	◆
Rated power (kW)		4.87	7.85	10.30	◆	◆	◆
R (ph-ph) (Ohms)		0.20	0.05	0.03	◆	◆	◆
L (ph-ph) (mH)		3.1	1.6	1.2	◆	◆	◆
Recommended power conn' size		1.5	1.5	1.5	◆	◆	◆

Motor frame size (mm)		190UD					
Voltage (Vrms)		380-480					
Frame length		A	B	C	D	E	F
Continuous stall torque (Nm)		18.5	32.7	52.0	62.0	73.5	85.0
Peak torque (Nm)		55.5	98.10	156	186	220.5	255
Standard inertia (kg cm <sup>2</sup> )		22.0	38.3	54.6	70.9	87.2	103.5
Winding thermal time constant (sec)		286	292	300	308	316	324
Standard motor weight (kg)		14.60	21.20	27.74	34.30	40.90	47.42
Number of poles		10	10	10	10	10	10
Speed 1000 (rpm)	K <sub>t</sub> (Nm/A) = K <sub>e</sub> (V/krpm) =			4.8 296			
Rated torque (Nm)		17.6	◆	◆	◆	◆	78.3
Stall current (A)		3.83	◆	◆	◆	◆	17.61
Rated power (kW)		1.83	◆	◆	◆	◆	8.12
R (ph-ph) (Ohms)		3.70	◆	◆	◆	◆	0.53
L (ph-ph) (mH)		101.4	◆	◆	◆	◆	15.8
Recommended power conn' size		1.5	◆	◆	◆	◆	1.5
Speed 1500 (rpm)	K <sub>t</sub> (Nm/A) = K <sub>e</sub> (V/krpm) =			3.2 196			
Rated torque (Nm)		◆	◆	46.2	◆	◆	68.5
Stall current (A)		◆	◆	16.25	◆	◆	26.56
Rated power (kW)		◆	◆	7.26	◆	◆	10.76
R (ph-ph) (Ohms)		◆	◆	0.55	◆	◆	0.23
L (ph-ph) (mH)		◆	◆	14.2	◆	◆	6.8
Recommended power conn' size		◆	◆	1.5	◆	◆	1.5
Speed 2000 (rpm)	K <sub>t</sub> (Nm/A) = K <sub>e</sub> (V/krpm) =			2.4 147			
Rated torque (Nm)		◆	◆	42.5	45.3	52.9	56
Stall current (A)		◆	◆	21.67	25.83	30.63	35.42
Rated power (kW)		◆	◆	8.90	9.49	11.08	11.73
R (ph-ph) (Ohms)		◆	◆	0.32	0.17	0.16	0.14
L (ph-ph) (mH)		◆	◆	8.2	5.1	4.6	4.3
Recommended power conn' size		◆	◆	1.5	1.5	1.5	1.5
Speed 3000 (rpm)	K <sub>t</sub> (Nm/A) = K <sub>e</sub> (V/krpm) =			1.6 98			
Rated torque (Nm)		15.5	25.0	32.8	39.0	◆	◆
Stall current (A)		11.56	20.44	32.50	38.75	◆	◆
Rated power (kW)		4.87	7.85	10.30	12.25	◆	◆
R (ph-ph) (Ohms)		0.57	0.23	0.11	0.11	◆	◆
L (ph-ph) (mH)		11.6	5.7	3.1	2.7	◆	◆
Recommended power conn' size		1.5	1.5	1.5	1.5	◆	◆

◆ Not available

All data subject to +/-10% tolerance. Stall torque, rated torque and power relate to maximum continuous operation tested in a 20°C ambient at 12kHz drive switching frequency. All other figures relate to a 20°C motor temperature. Maximum intermittent winding temperature is 140°C

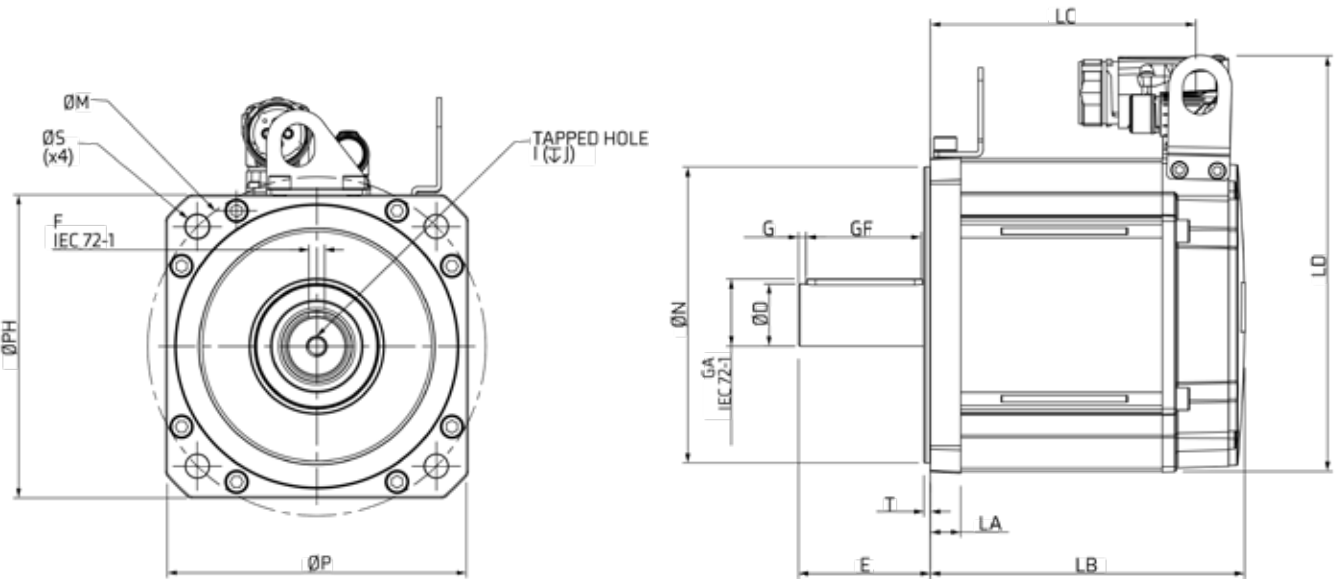

Motor Dimension													
	Unbraked length	Braked length		Flange thickness	Register length	Register diameter	Overall height	Flange square	Fixing hole diameter	Fixing hole PCD	Motor housing	Mounting bolts	
	LB (±0.9)	LC (±1.0)	LC (±1.0)	LC (±1.0)	LA (±0.5)	T (±0.1)	N (j6)	LD (±0.3)	P (±0.3)	S (H14)	M (±0.5)	PH (±0.5)	
190A	160.6	131.1	259.1	229.6									
190B	190.6	161.1	289.1	259.6									
190C	220.6	191.1	319.1	289.6									
190D	250.6	221.1	349.1	319.6	18.5	3.9	180	252.5	190.3	14.5	215	190	M12 mm
190E	280.6	251.1	379.1	349.6									
190F	310.6	281.1	409.1	379.6									

Shaft Dimension									
	Shaft diameter	Shaft length	Key height	Key length	Key to shaft end	Key width	Tapped hole thread size	Tapped hole depth	
	D(j6)	E	GA	GF	G	F(h9)	I	J(±1)	
38.0 Std	38	80	41	70	4.6	10	M12 x 1.75	29	mm

42mm shaft and 235mm flange options are available. Refer to factory for more information.

# DRIVE OBSESSED



**Control Techniques has been designing and manufacturing the best variable speed drives in the world since 1973.**

**Our customers reward our commitment to building drives that outperform the market. They trust us to deliver on time every time with our trademark outstanding service.**

More than 45 years later, we're still in pursuit of the best motor control, reliability and energy efficiency you can build into a drive. That's what we promise to deliver, today and always.

**1.5K+**

**Employees**

**70**

**Countries**

# #1 FOR ADVANCED MOTOR AND DRIVE TECHNOLOGY



**Nidec Corporation is a global manufacturer of electric motors and drives.**

**Nidec was set up in 1973. The company made small precision AC motors and had four employees. Today, it's a global corporation that develops, builds and installs cutting-edge drives, motors and control systems in over 70 countries with a workforce of more than 110,000.**

You'll find its innovations in thousands of industrial plants, IoT products, home appliances, cars, robotics, mobile phones, haptic devices, medical apparatus and IT equipment all over the world.

**112K**

**Employees**

**\$14.2B**

**Group Turnover**

**44+**

**Countries**

**337+**

**Companies**



**CONTROL TECHNIQUES.  
NO ONE KNOWS DRIVES LIKE WE DO.**

Our drive obsessive representatives will drive you in the right direction and give you first class support whenever you need it.

For more information, or to find your local drive centre, visit:

**[www.controltechniques.com](http://www.controltechniques.com)  
[www.driveobsessed.com](http://www.driveobsessed.com)**

Connect with us



©2022 Nidec Control Techniques Limited. The information contained in this brochure is for guidance only and does not form part of any contract. The accuracy cannot be guaranteed as Nidec Control Techniques Ltd have an ongoing process of development and reserve the right to change the specification of their products without notice.

Nidec Control Techniques Limited. Registered Office: The Gro, Newtown, Powys SY16 3BE.

Registered in England and Wales. Company Reg. No. 01236886.

P.N. 0778-0502-09 01/22

