

Nidec
All for dreams



*Installation, commissioning
and maintenance*



LSHRM - FLSHRM - PLSHRM

*Dyneo+: magnet
assisted reluctance
motors*

Reference: 5411 en - 2019.04 / b

LEROY-SOMERTM

GENERAL WARNING

These symbols    appear in this document whenever it is important to take special precautions during installation, operation, maintenance or servicing of the motors.

It is essential that electric motors are installed by experienced, qualified and authorized personnel.

In accordance with the main requirements of EC Directives, the safety of people, animals and property should be ensured when fitting the motors into machines.

Particular attention should be paid to equipotential bonding ground or earthing connections.

The following precautions must be taken before working on any stationary device:

- **AC voltage disconnected and no residual voltage present**
- **Careful examination of the causes of the stoppage (jammed transmission - loss of phase - cut-out due to thermal protection - lack of lubrication, etc.)**



Even when not supplied with power, there is voltage at the terminals of a rotating magnet-assisted reluctance motor.

Accordingly, before carrying out any work, check carefully that the motor is not rotating.



 **When dismantling the motor only**

The rotor must not be assembled or maintained by people with pacemakers or any other implanted medical electronic device.

The motor rotor contains a magnetic field. If the rotor is separated from the motor, its field can affect pacemakers or disturb digital devices such as watches, mobile phones, etc. No magnetized dust must be present in the working environment, which must be kept clean.

Dear Customer,

You have just acquired a Leroy-Somer motor.

This motor benefits from the experience of one of the largest manufacturers in the world, using state-of-the-art technologies – automation, specially selected materials and rigorous quality control. As a result, the regulatory authorities have awarded our motor factories ISO 9001, Edition 2015 international certification from the DNV. Similarly our environmental approach has enabled us to obtain ISO 14001: 2015 certification.

Products for particular applications or those designed to operate in specific environments are also approved or certified by the following organizations: CETIM, LCIE, DNV, ISSEP, INERIS, CTICM, UL, BSRIA, TUV, CCC, EAC, which check their technical performance against the various standards or recommendations.

We thank you for making this choice, and would ask you to read the contents of this manual.

By observing a few essential rules, you will ensure problem-free operation for many years.

Moteurs Leroy-Somer

CE conformity

The motors comply with the Low Voltage Directive 2014/35/EU, the Electromagnetic Compatibility Directive 2014/30/EU, the ROHS II Directive 2011/65/EU and the ErP Directive 2009/125/EC, and standards referring thereto.

Our products can be incorporated in machines subject to the Machinery Directive 2006/42/EC.

Note:

Leroy-Somer reserves the right to modify the characteristics of its products at any time in order to incorporate the latest technological developments. The information contained in this document is therefore liable to be changed without notice.

Copyright 2019: Moteurs Leroy-Somer

This document is the property of Leroy-Somer. It may not be reproduced in any form without prior authorization. All brands and models have been registered and patents applied for.

1 - RECEIPT	6
1.1 - Identification	6
1.2 - Storage	7
2 - POSITION OF LIFTING RINGS	7
3 - ASSEMBLY AND COMMISSIONING RECOMMENDATIONS	9
3.1 - Checking the insulation	9
3.2 - Location - ventilation	9
3.2.1 - Enclosed motors	9
3.2.2 - Drip-proof motors	10
3.2.3 - Installation	10
3.3 - Coupling	10
3.4 - Motor protection	13
3.4.1 - Recommendations for variable speed systems	13
3.4.2 - Thermal protection	13
3.4.3 - Protection against condensation: optional space heaters	14
3.4.4 - Winding protection system	15
3.4.5 - Rotation mechanism protection system	15
3.5 - Connections	16
3.5.1 - Good wiring practices	16
3.5.1.1 - General	16
3.5.1.2 - Equipotential bonding and earthing	16
3.5.1.3 - Drive power supply cables	16
3.5.1.4 - Motor cables	16
3.5.1.5 - Sizing of power cables	17
3.5.1.6 - Connecting the control system	18
3.5.1.7 - Typical connection of the motor and drive package	18
3.5.2 - Terminal box and cable gland position	18
3.5.3 - Motor connections	19
3.5.3.1 - (F)LSHRM and PLSHRM motors	19
3.5.3.2 - Earth terminal	19
3.5.3.3 - Connecting the power supply cables to the terminal block	19
3.5.4 - Power supply cable cross-sections	21
3.5.5 - Forced ventilation option	21
3.5.6 - Connecting protection devices in the terminal box	21
3.5.7 - Connecting PTC sensors to the Powerdrive MD2	21
3.5.8 - Wiring a resolver	22

4 - COMMISSIONING THE MOTOR-DRIVE	23
5 - ROUTINE MAINTENANCE	23
5.1 - Checking	23
5.2 - Bearings and greasing	24
5.2.1 - Type of grease	24
5.2.2 - Permanently greased bearings	24
5.2.3 - Bearings with grease nipples	24
5.3 - Bearing maintenance	24
6 - PREVENTIVE MAINTENANCE.....	25
7 - TROUBLESHOOTING GUIDE.....	26
8 - SPARE PARTS.....	27

RECEIPT

1 - RECEIPT

Check that your motor has not been damaged in transit upon receipt.

If there are obvious signs of damage, contact the carrier (you may be able to claim on their insurance) and after a visual check, run the motor to detect any malfunctions.

1.1 - Identification

As soon as you receive the motor, check that the nameplate on the machine conforms to your order.

Definition of symbols used on nameplates:



Legal mark indicating the conformity of equipment with the requirements of European Directives.

3 ~: three-phase AC motor

4P: number of poles

LSHRM: series

315: frame size

MP: housing designation and manufacturer code

TC: impregnation index

IE5: performance as per 60034-30-2 corresponding to the top row in the table of motor data

V	Hz	min ⁻¹	kW	cosφ	A	eff %	Inv. supply (V)
Y 490	50	1500	160	0.86	303	97.3	380-460
Y 490	60	1800	160	0.92	296	97.2	Nmax/min-9
Y 490	60	1800	164	0.86	294	97.2	7000
Δ 490	67	2500	217	0.84	544	95.6	min.Fsw (kHz) 3

BEMF (V/kmin ⁻¹)	DBC (A)	Lq@0A (mH)	Lq@DBC (mH)	Ld@DBC (mH)	α@DBC (°)	α@DBC/2 (°)
Y 75	336	6.52	4.20	0.71	62	51
Δ 43	583	2.17	1.40	0.24	62	51

Motor

686251: motor batch number

C: month of production

19: year of production

001: serial number

IP55 IK08: protection index

kg: weight

Ta 50°C: contractual ambient operating temperature

Ins. cl. F: insulation class F

S9: service

1000 m : maximum altitude without derating

DE: Drive End - Drive-end bearing

NDE : Non Drive End - Bearings opposite the drive-end

IB: Insulated Bearing

SGR: Shaft Grounding Ring

RIS: Reinforced Insulation System

POLYREX EM 103: type of grease

48 g: quantity of grease at each regreasing

6200 h: regreasing interval (in hours) for the ambient temperature (Ta)

⊠ : vibration level

⊕ : balancing mode

Characteristics

V: motor voltage rating

Hz: supply frequency

min⁻¹: revolutions per minute (rpm)

kW: power rating

cos φ: power factor

A: current rating

eff%: efficiency

Inv. supply: drive supply voltage

Nmax (min⁻¹): maximum speed

min.Fsw (kHz): minimum switching frequency

BEMF (V / kmin⁻¹): electromotive force

DBC (A) : design current

Lq@0A (mH): unsaturated quadratic inductance at 0 amperes

Lq@DBC (mH): saturated quadratic inductance at design current

Ld@DBC (mH): saturated direct inductance at design current

α@DBC (°): load angle at design current

α@DBC/2 (°): load angle at 50% of design current

POSITION OF LIFTING RINGS

1.2 - Storage

Prior to commissioning, motors should be stored:

- away from humidity: at relative humidity levels above 90%, the machine insulation can drop very quickly and become virtually non-existent at around 100%. The state of the anti-rust protection on unpainted parts should be monitored.

For prolonged storage longer than 3 months, place the machine in a sealed waterproof covering (for example heat-shrunk plastic) containing sachets of desiccant corresponding to the volume and relative humidity of the location:

- away from frequent significant variations in temperature to avoid the risk of condensation. During storage the drain plugs must be removed to allow condensation water to escape (located at the lowest point depending on the operating position).

This location must be dry and protected from harsh weather conditions, cold (temperature between -40°C and +80°C), free from vibration, dust and corrosive gases.

- if the surrounding area vibrates, try to reduce the effect of these vibrations by placing the motor on a damping support (rubber plate or similar).

Rotate the rotor a fraction of a turn once a fortnight to prevent the bearing rings from becoming marked.

- do not remove the rotor locking device (if there are roller bearings).

Even if the motor has been stored in the correct conditions, certain checks must be carried out before it is started up:

• Greasing

Non-regreasable bearings

Maximum storage: 3 years. After this time, replace the bearings.

Regreasable bearings

Storage period	less than 1 year	The motor can be commissioned without regreasing.
	more than 1 year, less than 2 years	Regrease before commissioning, as described in section 5.2
	more than 2 years less than 5 years	Dismantle the bearing - Clean it - Replace the grease completely
	more than 5 years	Change the bearing - Regrease it completely

Greases used by Leroy-Somer: see nameplate

2 - POSITION OF LIFTING RINGS

 **Position of the lifting rings for lifting the motor only (not connected to the machine).**

Labour regulations stipulate that all loads over 25 kg must be fitted with lifting devices to facilitate handling.

The positions of the lifting rings and the minimum dimensions of the loading bars are given below in order to help with preparation for handling the motors. If these precautions are not followed, some items of equipment, such as the terminal box, protective cover or drip cover, could be warped or crushed.

 **Motors intended for use in the vertical position are sometimes delivered in the horizontal position on a pallet. When the motor is pivoted, the shaft must under no circumstances be allowed to touch the ground, as the bearings could be irreparably damaged. Moreover, additional special precautions must be taken, as the integral motor lifting rings are not designed for pivoting the motor.**

POSITION OF LIFTING RINGS

• Horizontal position

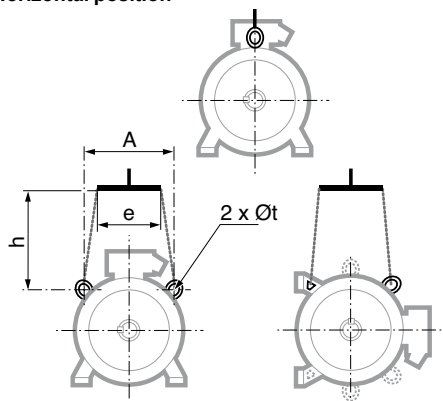

• Vertical position

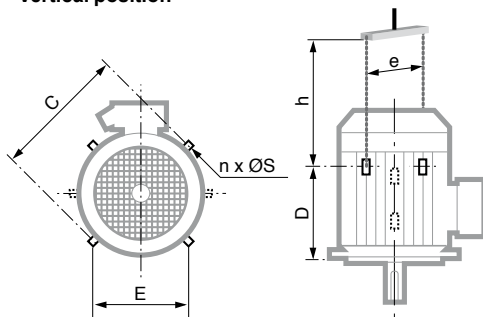

Type	Horizontal position (mm)			
	A	min. th	min. h	Øt
LSHRM 132 M1 / MU1 / MU3 / SM1	200	180	150	14
LSHRM 160 LR1 / LR3 / MR1	200	180	150	14
LSHRM 180 L1 / L1M / M1	200	260	150	14
LSHRM 200 LR1 / LQ1	200	260	150	14
LSHRM 225 MY1 / SZ1	200	260	150	14
LSHRM 225 MG / MG1M / SG1	360	380	200	30
LSHRM 250 ME / MF1 / SF1 / SF1S	360	380	200	30
LSHRM 280 MC / MD / SC / SD	360	380	200	30
LSHRM 280 MU / MUS	400	400	500	30
LSHRM 315 MN1 / SN1	360	380	200	30
LSHRM 315 MP / MR / MRS	400	400	500	30
FLSHRM 280 MA / MD / SA / SB	360	380	200	30
FLSHRM 315 LTA / LTB / MT / STA / STB	360	380	200	30
FLSHRM 315 LA / LB / M	400	400	500	30
FLSHRM 355 LTA / LTB / LTC	400	400	500	30
PLSHRM 315 LD	400	400	500	30

Type	Vertical position (mm)						
	C	E	D	n**	ØS	e _{min.}	h _{min.}
LSHRM 132 M1 / MU1 / MU3 / SM1							
LSHRM 160 LR1 / LR3 / MR1							
LSHRM 180 L1 / L1M / M1	390	265	290	2	14	390	320
LSHRM 200 LR1 / LQ1	410	300	295	2	14	410	450
LSHRM 225 MY1 / SZ1	410	300	295	2	14	410	450
LSHRM 225 MG / MG1M / SG1	480	360	405	4	30	500	500
LSHRM 250 ME / MF1 / SF1 / SF1S	480	360	405	4	30	500	550
LSHRM 280 MC / MD / SC / SD	480	360	405	4	30	500	500
LSHRM 280 MU / MUS	630	-	570	2	30	630	550
LSHRM 315 MN1 / SN1	480	360	405	4	30	500	500
LSHRM 315 MP / MR / MRS	630	-	570	2	30	630	550
FLSHRM 280 MA / MD / SA / SB	480	360	405	4	30	500	500
FLSHRM 315 LTA / LTB / MT / STA / STB	480	360	405	4	30	500	500
FLSHRM 315 LA / LB / M	630	-	570	2	30	630	550
FLSHRM 355 LTA / LTB / LTC	630	-	570	2	30	630	550
PLSHRM 315 LD	630	-	570	2	30	630	550

* If the motor is fitted with a drip cover, allow an additional 50 to 100 mm to avoid damaging it when the load is swung.

** If n = 2, the lifting rings form an angle of 90° with respect to the terminal box axis. If n = 4, this angle becomes 45°.

3 - ASSEMBLY AND COMMISSIONING RECOMMENDATIONS

In all cases, compatibility of the motor and its environment must be guaranteed before its installation and also throughout its life.

 Electric motors are industrial products. They must therefore be installed by qualified, experienced and authorised personnel. The safety of people, animals and property must be ensured when fitting the motors into machines (please refer to current standards).

3.1 - Checking the insulation

 Before starting the motor, it is advisable to check the insulation between the phases and earth, and between phases.

This check is essential if the motor has been stored for longer than 6 months or if it has been kept in a damp atmosphere.

This measurement must be carried out using a megohmmeter at 500 volts DC (do not use a magnetoelectric system). It is better to carry out an initial test at 30 or 50 volts and if the insulation is greater than 1 megohm, carry out a second test at 500 volts DC for 60 seconds, between the winding and ground (on U then V then W). The insulation value must be at least 10 megohms in cold state.

If this value cannot be achieved, or routinely if the motor might have been splashed with water or salt spray, or kept for a long period in a very humid place, or if it is covered with condensation, the motor should be dried using the optional space heaters if the motor has them (see section 3.4.3).

 Do not apply the megohmmeter to the terminals of the temperature sensors as this can damage them.

For any insulation or high voltage test, it is advisable to connect the temperature sensors and/or accessories to ground.

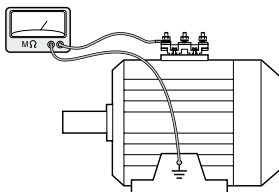

 **Caution:** If the high voltage test, carried out at the factory before dispatch, needs to be repeated, this should be performed at half the standard voltage, i.e.: $1/2 (2U + 1000 V)$. Check that the capacitive effect resulting from the high voltage test is eliminated before connecting the terminals to ground.

3.2 - Location - ventilation

The motor must be installed in a ventilated place, with clearance for the air inlet and outlet.

Obstruction (clogging) – even accidental – of the ventilation circuit has an adverse effect on motor operation. With drip-proof motors, do not obstruct the air inlet with a coupling guard, provide a perforated plate.

It is also necessary to check that the hot air is not being recycled. If it is, pipes must be provided for the intake of cold air and expulsion of hot air, in order to prevent an abnormal increase in motor temperature.

In this case, if the air is not circulated by an auxiliary fan, the dimensions of the pipes must be such that the pressure losses are negligible compared to those of the motor.

3.2.1 - Enclosed motors

Our motors are cooled in accordance with method IC 411 (standard IEC 60034-6) i.e. “machine cooled by its surface, using the ambient fluid (air) flowing along the machine”.

The fan at the non-drive end cools the motor. Air is sucked in through the grille of a fan cover (which provides protection against the risk of direct contact with the fan in accordance with standard IEC 60034-5) and blown along the housing fins to ensure the thermal equilibrium of the motor in any direction of rotation.

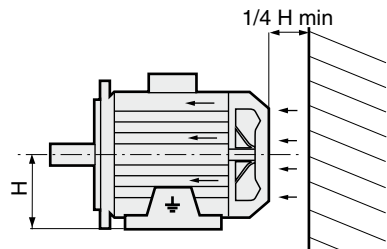

3.2.2 - Drip-proof motors

Our motors are cooled in accordance with method IC 01 (standard IEC 60034-6) i.e. "machine cooled by means of the ambient fluid (air) circulating inside the machine". A fan at the non-drive end cools the motor. Air is sucked in at the motor drive end and blown along the fan cover to ensure the thermal equilibrium of the motor in any direction of rotation.

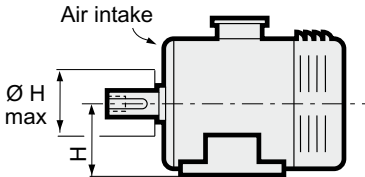

3.2.3 - Installation

The motor must be mounted in the position specified on the order, on a base which is rigid enough to prevent distortion and vibration.

If the motor feet have six fixing holes, it is preferable to use those which correspond to the standard dimensions for the motor power rating (refer to the motors technical catalogue) or, should this not be the case, to those shown at B2.

Provide easy access to the terminal box, the condensation drain plugs and, if appropriate, to the grease nipples.

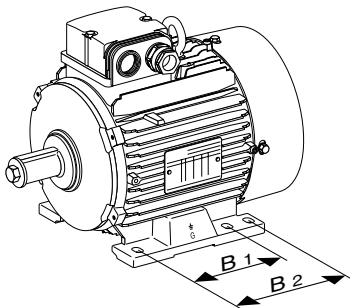

Use lifting equipment which is compatible with the weight of the motor (indicated on the nameplate).



When the motor is fitted with lifting rings, they are for lifting the motor on its own and must not be used to lift the whole machine after the motor has been fitted to it.

Note 1: When installing a suspended motor, it is essential to provide protection in case the fixing breaks.

Note 2: Never stand on the motor.

3.3 - Coupling

• Preparation

Rotate the motor before coupling to detect any possible fault due to handling.

Remove any protection from the shaft extension.

Note: the rotor magnets can resist rotation slightly.

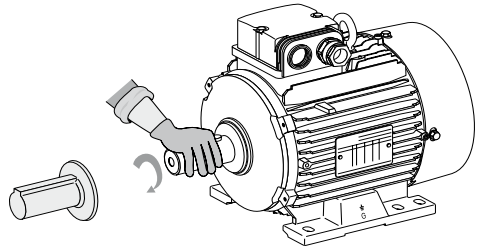

Drain off any condensation water that has formed inside the motor by removing the plugs from the drain holes and refitting these plugs to guarantee the IP rating.

• Rotor locking device

For made-to-order motors with roller bearings, remove the rotor locking device.

In exceptional circumstances when the motor has to be moved after the coupling device has been fitted, the rotor must be re-immobilized.

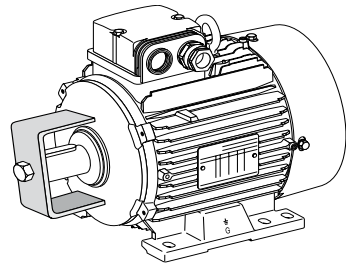

Balancing

Rotating machines are balanced in accordance with standard ISO 8821:

- half-key when the shaft extension is marked H
- no key when the shaft extension is marked N
- full key when the shaft extension is marked F

any coupling element (pulley, coupling sleeve, slip-ring, etc.) must therefore be balanced accordingly. Check the motor nameplate for balancing information.

ASSEMBLY AND COMMISSIONING RECOMMENDATIONS

The motors are balanced with a half-key as standard unless otherwise indicated. The coupling balancing will therefore need to be adapted to motor balancing, and the coupling will need to be adapted to the length of the shaft key; alternatively any visible parts protruding from the key can be machined off. A suitable key can be used.



Failure to follow these recommendations could lead to premature wear of the bearings and invalidate the warranty.

CORRECT ASSEMBLY

Coupling adjusted to the length of the key

Machining of the visible, projecting parts of the key

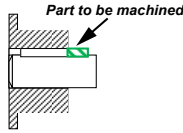
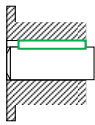

INCORRECT ASSEMBLY

Protruding, non-machined key

Coupling not adjusted to the length of the key

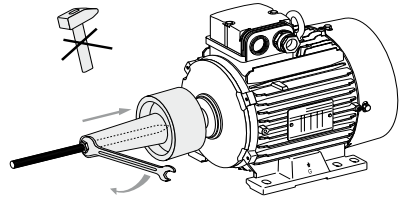
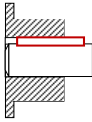

The hub of the transmission device must be:

- fully in contact with the shoulder of the shaft or, if this is missing, hard up against the metal stop ring (do not crush the seal);
- longer than the shaft extension (by 2 to 3 mm) so that it can be tightened using a screw and washer. If it is not longer, a spacer ring must be inserted without cutting the key (if this ring is large, it must be balanced).

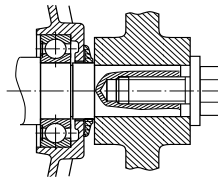

Bearing against the shaft shoulder

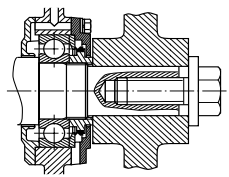

Bearing against the stop ring

Inertia flywheels must not be mounted directly onto the shaft extension, but installed between end shields and connected by a coupling sleeve.



If a motor is started up without a coupling device having been fitted, carefully immobilize the key in its housing.

Beware of backdriving when the motor is switched off. Appropriate precautions must be taken:

- for pumps, install a non-return valve.
- for mechanical devices, install a backstop or a holding brake.
- etc.

• Tolerances and adjustments

The standard tolerances are applicable to the mechanical characteristics given in our catalogues. They comply fully with the requirements of IEC standard 72-1.

- Adhere strictly to the instructions provided by the transmission device supplier.
- Avoid impacts which could damage the bearings.

Use a wrench and grease the tapped hole of the shaft extension with a special lubricant (e.g. molykote grease) to make it easier to fit the coupling.

• Mounting a face mounted motor

Mounting face mounted motors IM B14 (IM 3601) and IM B34 (IM 2101).

Max. screw insertion length when mounting face mounted motors IM B34 and IM B14.

	Max. insertion (mm)
LSHRM 132 FT165	11
LSHRM 160 FT215	15

• Direct connection to the machine

When the rotating device (pump or fan turbine) is mounted directly on the motor shaft end, check that this device is perfectly balanced and that the radial force and the axial thrust are within the limits indicated in the catalogue for bearing strength.

• Direct connection using a coupling sleeve

The coupling sleeve must be selected based on the torque rating to be transmitted and the safety factor depending on the starting conditions for the electric motor.

ASSEMBLY AND COMMISSIONING RECOMMENDATIONS

The machines must be carefully aligned, so that any lack of concentricity and parallelism in the two coupling halves is compatible with the coupling sleeve manufacturer's recommendations.

The two parts of the coupling sleeve should be provisionally assembled to make it easier to alter their relative position.

Adjust the parallel plane of both shafts using a gauge. Measure the distance between the two coupling surfaces at one point on the circumference. Rotate them 90°, 180° and 270° in relation to this initial position, and measure each time. The difference between the two extreme values of dimension "x" must not exceed 0.05 mm for standard couplings.

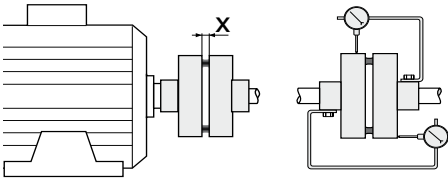

To perfect this adjustment and at the same time check the concentricity of the two shafts, fit 2 gauges as shown in the diagram and slowly turn both shafts.

The deviations registered for either shaft will indicate the need for axial or radial adjustment if deviation exceeds 0.05 mm.

• Direct connection using a rigid coupling

The two shafts must be aligned to adhere to the coupling sleeve manufacturer's tolerance intervals.

Maintain the minimum distance between the shaft extensions to allow the motor shaft and the load shaft to expand.

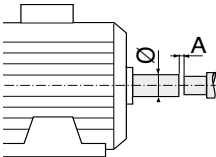

∅ (mm)	A (mm) min.
28 to 55	1
60-65	1.5
75 to 95	2

• Transmission via belt pulleys

The user chooses the diameter of the pulleys.

Cast iron pulleys with a diameter over 315 are not recommended for rotation speeds of 3,000 rpm.

Flat belts cannot be used for rotation speeds of 3,000 rpm or more.

Comply with the supplier's recommendations.

• Positioning belts

Allow for a possible approx. 3% adjustment with respect to the calculated distance E to ensure that the belts can be correctly positioned.

Force must never be used when fitting the belts.

For notched belts, position the notches in the pulley grooves.

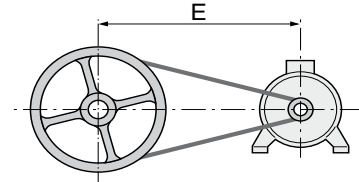

• Aligning pulleys

Check that the motor shaft is completely parallel with that of the receiving pulley.

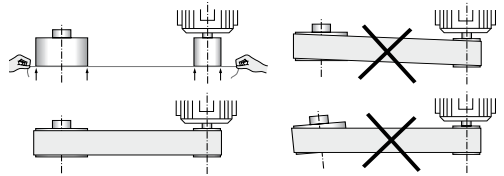

Protect all rotating devices before power-up.

• Adjusting belt tension

Belt tension must be adjusted very carefully in accordance with the recommendations of the belt supplier and product design calculations.

Reminder:

- excessive tension = unnecessary force on the end shields which could lead to premature wear of the rotation mechanism (end shield-bearings) and eventually break the shaft.

inadequate tension = vibration (wear to the rotation mechanism).

• Fixed distance between centres:

Place a belt tensioning pulley on the slack side of the belts:

- smooth pulley on the outside of the belt

- grooved pulley on the inside of the belts when using V-belts.

• Adjustable distance between centres:

The motor is usually mounted on slide rails, which ensures that pulley alignment and belt tension can be adjusted in the most optimum manner.

Place the slide rails on a perfectly horizontal baseplate. The lengthways position of the slide rails is determined by the length of the belt, and the crossways position by the pulley of the machine driven.

ASSEMBLY AND COMMISSIONING RECOMMENDATIONS

Mount the slide rails using the tensioner screws in the direction shown in the diagram (with the slide rail screw on the belt side between the motor and the machine driven).

Fix the slide rails to the baseplate and adjust the belt tension as before.

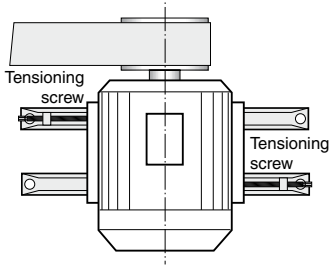

- **Other built-in indirect thermal protection devices**
As an option, specific sensors (see table below) can be fitted on the motor to monitor temperature changes at "hot spots":
 - overload detection
 - cooling check
 - monitoring strategic points for the purposes of system maintenance.

 **It must be emphasized that under no circumstances can these sensors be used to control the motor operating cycles directly.**

• Bearing protection

Dyneo+ motors can be fitted with PTC sensors in the end shields to cut-off the power in the event that the bearings heat up abnormally. These sensors can (optionally) be mounted on all motors in the range or replaced with PT1000 sensors for continuous monitoring.

3.4 - Motor protection

3.4.1 - Recommendations for variable speed systems

Special precautions must be taken when using synchronous motors powered via a variable speed drive: during prolonged operation at low speed, cooling efficiency is greatly diminished. It is therefore advisable to install a forced ventilation unit that will produce a constant flow of air at any motor speed.

 **Caution: make sure you comply with the drive supply voltages specified on the motor rating plate ($\pm 10\%$). Outside this tolerance range, there is a risk of overheating**

3.4.2 - Thermal protection

The motors are protected by the variable speed drive, placed between the isolating switch and the motor.

• Built-in thermal protection devices as standard

The motors are fitted with PTC and PT1000 sensors as standard.



PTC sensors (inserted in the windings) are dedicated to the thermal protection of the motor.

The PT1000 sensor (inserted in the windings) is exclusively used to monitor motor temperature (alarm management or temperature tracking).

For information on how to connect sensors and drive settings, refer to section 3.5.6.

 **Motor PTC sensors must be connected in order to maintain optimum protection.**

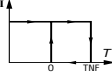
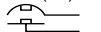
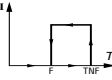
ASSEMBLY AND COMMISSIONING RECOMMENDATIONS

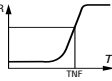
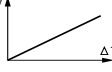
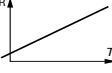
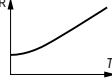
Type	Operating principle	Operating curve	Breaker rating (A)	Protection provided	Mounting Number of devices*
Normally open thermal protection PTO	Bimetallic strip, indirectly heated, with normally open (NO) contact 		2.5 A at 250 V with $\cos \varphi$ 0.4	general surveillance for non-transient overloads	Mounted in control circuit 2 or 3 in series
Normally closed thermal protection PTF	Bimetallic strip, indirectly heated, with normally closed (Nc) contact 		2.5 A at 250 V with $\cos \varphi$ 0.4	general surveillance for non-transient overloads	Mounted in control circuit 2 or 3 in parallel
Positive temperature coefficient thermistor PTC	Non-linear variable resistor, indirectly heated 		0	general surveillance for transient overloads	Mounted with associated relay in control circuit 3 in series
Thermocouples T ($T < 150^\circ\text{C}$) Constantan Copper K ($T < 1000^\circ\text{C}$) Copper-nickel	Peltier effect		0	high accuracy of hot spots at regular intervals	Mounted in control boards with associated reading equipment (or recorder) 1 per hot spot
Platinum temperature sensor PT 100	Non-linear variable resistor, indirectly heated		0	high accuracy continuous surveillance of key hot spots	Mounted in control boards with associated reading equipment (or recorder) 1 per hot spot
Temperature sensor PT 1000	Resistance depending on the winding temperature		0	high accuracy continuous surveillance of key hot spots	Mounted in control boards with associated reading equipment (or recorder) 1 per hot spot

- NRT: nominal running temperature
- NRTs are chosen according to the position of the sensor in the motor and the temperature increase class.

* The number of devices relates to the winding protection.

• Alarm and early warning

All thermal protection devices can be backed up by another type of protection (with different NRTs). The first device will then act as an early warning (light or sound signals given without shutting down the power circuits), and the second device will be an alarm (which shuts down the power circuits).



Caution: the motor may still be live despite having stopped. Ensure that the AC supply is disconnected before any work is carried out in the terminal box or in the cabinet.

3.4.3 - Protection against condensation: optional space heaters

Marking: 1 red label

A fibre glass flexible resistor is fixed on 1 or 2 coil end turns. This resistor heats the machines when stopped and thus prevents condensation inside the machines.

Power supply: 230 V single-phase unless otherwise specified by the customer.

When the motor is running, the space heater power supply must be switched off.

If the drain plugs at the bottom of the motor were not removed at the time of installation, they must be opened approximately every 6 months.



Caution: Check that the space heaters are powered down before any work is carried out in the terminal box or in the cabinet.

3.4.4 - Winding protection system

Leroy-Somer can provide 2 levels of motor insulation:

- **Standard motor winding insulation system** with $\hat{U}_{LL} < 1500$ Vpk and $\hat{U}_{LE} < 1100$ Vpk.
- **Reinforced motor winding insulation system (RIS)** with $\hat{U}_{LL} < 1800$ Vpk and $\hat{U}_{LE} < 1300$ Vpk.

NOTE

- \hat{U}_{LL} : Peak voltage between phases (Vpk)
- \hat{U}_{LE} : Peak voltage between phase and earth (Vpk)
- For values of \hat{U}_{LL} or \hat{U}_{LE} higher than those mentioned above, please consult Leroy-Somer.
- The term "standard insulation" includes the standard built-in protection devices for certain motor ranges, for which no optional protection is necessary.

The table below defines the level of protection required for each application and the installation conditions. There are two levels of applications:

- **A1 applications:** All applications that do not meet the criteria listed under "A2 applications". For example, centrifugal pumps, fans, extruders and compressors, etc.
- **A2 applications:** All applications that meet one of the following criteria:
 - the drive has an active rectifier ("Low harmonic", "Regen"),
 - the drive has a braking transistor whose cumulative braking time is greater than 5% of total operating time.
 For example, materials handling, cranes, power generation, etc.

Mains voltage	≤ 510Vac		510 to 750Vac
Application	A1	A2	
Motor cable length			
10 m	Standard insulation		
20 m	RIS and/or optional filter ⁽¹⁾		
~ 100 m ⁽²⁾	RIS and/or optional filter ⁽¹⁾		

⁽¹⁾ Reinforced insulation system RIS
⁽²⁾ Beyond 100 m, limitations not related to winding protection must be taken into account. These limitations depend mainly on the power of the motor-drive. Refer to the good practice guide ref. 5626.

Conditions of table validity:

- Maximum dV/dt < 4000 V/μs at the terminals of the drive
- Minimum time between 2 PWM pulses of the drive: 5 μs

3.4.5 - Rotation mechanism protection system

Leroy-Somer provides several levels of protection of its motor bearings:

- **Standard rotation mechanism** (for B1 applications)
- **Reinforced protection systems for the rotation mechanism** to prevent common mode currents: **insulated bearings** and **shaft grounding ring** (for B2 applications or voltage greater than 510 V)

- **B1 applications:** All applications that do not meet the criteria listed under "B2 applications". For example, the centrifugal pumps, the fans, the compressors, etc.
- **B2 applications:** All applications that meet one or more of the following criteria:
 - the drive has an active rectifier ("Low harmonic", "Regen"),
 - the drive has a braking transistor whose cumulative braking time is greater than 5% of the total operating time.
 - the low speed limit is less than 500 rpm (example: extruders).
 For example, materials handling, cranes, extrusion, power generation, etc.

The term "Standard mechanism of rotation" includes the standard built-in protection devices for certain types of motor, for which no optional protection is necessary. The standard rotation mechanism of the range is as follows:

- The LSHRM/FLSHRM motors in the interchangeable range with a power ≥ 90kW at 1500 rpm and ≥ 160kW at 3000 rpm have an insulated non-drive end (NDE) bearing as well as a drive-end grounding ring.
- The LSHRM motors in the compact range with frame size ≥ 250 have an insulated non-drive end (NDE) bearing and a drive-end grounding ring
- The PLSHRM motors have insulated drive-end (DE) and non-drive end (NDE) bearings as well as a drive-end grounding ring.

The other motors in the range are not fitted with any specific protection devices.

The "reinforced rotation mechanism protection" system is required for B2 type applications or for supply voltages greater than 510 V.

This type of protection includes the following devices:

- The LSHRM/FLSHRM motors in the interchangeable range with a power $\geq 45\text{kW}$ at 1500 rpm and $\geq 55\text{kV}$ at 3000 rpm have an insulated non-drive end (NDE) bearing as well as a drive-end grounding ring.
- The LSHRM motors in the compact range with frame size ≥ 225 have an insulated non-drive end (NDE) bearing and a drive-end grounding ring.

NOTE

• The reinforced protection solution includes the use of an insulated speed or position sensor (absolute encoders, resolvers, etc.) when equipped with bearings in contact with the motor shaft. For more information, refer to the technical guide on speed and position sensors; ref. 5664.

3.5 - Connections

3.5.1 - Good wiring practices

3.5.1.1 - General

The user and/or the installer are responsible for connecting the motor and drive system in accordance with current legislation and regulations in the country of use. This is particularly important as concerns cable size and the connection of earthing and grounding components. The following information should never be used as a substitute for current standards, nor does it relieve the installation company of their liabilities.

3.5.1.2 - Equipotential bonding and earthing

The primary reason for grounding components and equipment in an industrial installation is to protect people and minimize the risk of damage in the event of a major fault on the power supply or following a lightning strike.

The second objective of earthing is to create an equipotential voltage reference with low impedance, common to all equipments that reduces:

- the risk of interference between equipment in installations which include sensitive interconnected electronic and electrical systems
- the risk of breaking equipment in the event of fault currents
- the risk of current flowing in the bearings of electrical machines supplied by frequency inverters
- the level of conducted or radiated electromagnetic emissions

It is essential that the earth network is designed and implemented by the installation supervisor so that its impedance is as low as possible, so as to distribute the fault currents and high-frequency currents without them passing through electrical equipment. The underlying philosophy of any earthing installation is to maximize mesh bonding of ground connections between metal parts (machine frame, building structures, pipework, etc.) and connect this mesh bonding to earth at multiple points. Metal grounds must be mechanically connected to each other with the largest possible electrical contact area or with grounding strips.

The motor housing must be connected to the equipment frame with high-frequency flat braids. For more information, see the guide to good practices for motor drive systems ref. 5626 (www.leroy-somer.com).

Under no circumstances can earth connections designed to protect people, by grounding metal parts via a cable, serve as a substitute for equipotential bonding (see IEC 61000-5-2).

In particular, the motor earth terminal (PE Protective Earth) must be connected directly to the drive earth terminal. One or more separate PE protective conductor(s) is(are) mandatory if the conductivity of the cable shielding is less than 50% of the conductivity of the phase conductor.

3.5.1.3 - Drive power supply cables

These cables do not necessarily need shielding. Refer to the drive documentation.

3.5.1.4 - Motor cables

Shielding the power conductors is the preferred method to ensure that common mode currents can return to their point of origin without dispersing into other possible paths (equipotential conductors, piping, building structure, etc.). This approach significantly reduces the levels of electromagnetic emissions, both conducted and radiated.

For this reason, shielded cables must be used between the drive and motor to ensure compliance with EMC emission standards (IEC 61800-3, etc.). Shielded cables are also used to limit shaft voltage and the risk of damage to the bearings.

• Shielded motor cables

Shielded cables must always be symmetrical multi-conductor cables with low stray capacity. Cables with a single equipotential bonding conductor can be used up to cross-sections of around 10 mm².

ASSEMBLY AND COMMISSIONING RECOMMENDATIONS

For larger cross-sections, always use cables with 3 equipotential bonding conductors. The shielding must be connected at both ends: drive end and motor end over 360°. The unshielded part of the cable must be as short as possible, and use metal cable glands (clamped onto the cable shield) on the motor end. Refer to the drive installation manuals for information on connecting the shielding at the drive end.

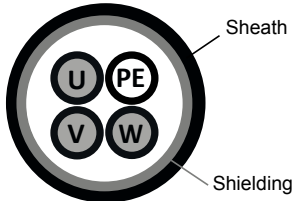

Cable cross-section $\leq 10 \text{ mm}^2$

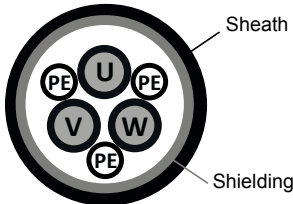

Cable cross-section $> 10 \text{ mm}^2$

All conductors must be placed in a metal conduit with 360° closure (e.g. a metal cable duct). This metal conduit must be mechanically connected to the electrical cabinet and the structure supporting the motor. If the conduit consists of several pieces, these should be interconnected by braids to ensure ground continuity (bonding). The cables must be positioned and held in a cloverleaf formation in the conduit.

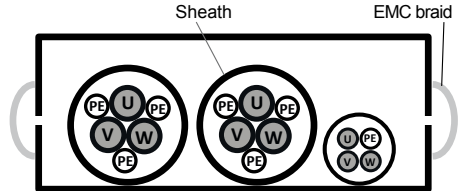

Unshielded cables in a metal conduit

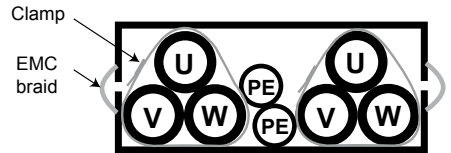

Unshielded cables in a conduit with several pieces.

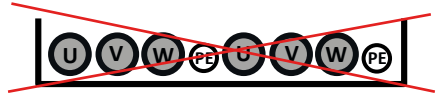

Configuration of unshielded cables not to be used.

⚠ Armoured or shielded single-conductor cables are not to be used



For applications that so require, the shielded cables can be replaced by cables with an external PE protection concentric conductor.

• Unshielded motor cables

In the second industrial environment (according to the EN 61800-3 standard, an environment including all establishments other than those directly connected to a low voltage power supply network that powers buildings used for residential purposes), if the power supply cable of the motor is short ($< 10 \text{ m}$), the shielded cable can be replaced by a cable with 3 phase conductors combined in cloverleaf pattern + 1 earth conductor.

3.5.1.5 - Sizing of power cables

The drive and motor power supply cables must be sized according to the applicable standard, and depending on the design current, stated in the drive documentation. The following factors must be taken into account:

- The installation method: in a conduit, a cable tray, suspended, etc.
- The type of conductor: copper or aluminium

Once the cable cross-section has been determined, check the voltage drop at the motor terminals. A significant voltage drop will lead to increased current and additional losses in the motor (temperature rise).

ASSEMBLY AND COMMISSIONING RECOMMENDATIONS

3.5.1.6 - Connecting the control system

Refer to the manual for the relevant drive. Also see section 3.5.7 on connecting a resolver.

3.5.1.7 - Typical connection of the motor and drive package

The following information is given for guidance only, and should never be used as a substitute for current standards, nor does it relieve the installation company of their liabilities.

The motor must be earthed in accordance with the applicable regulations (protection of workers).

CAUTION:

Installation of a sine filter or dv/dt filter at the drive output is not compatible with the control of LSHRM, FLSHRM or PLSHRM motors.

Equipotential bonding between the frame, motor, drive, transformer and ground carried out in accordance with good practices will significantly help reduce the voltage on the shaft and the motor casing, will reduce the passage of high-frequency currents via the shaft and, as a result, will prevent the risk of premature failure of the bearings or encoders.

For more information, see the guide to good practices for motor drive systems ref. 5626 (www.leroy-somer.com).

3.5.2 - Terminal box and cable gland position

The terminal box is placed as standard on the top of the motor near the drive end, for forms IM B3 and B5, and has IP55 protection.

Positions B and D are not allowed for FLSHRM & PLSHRM motors.

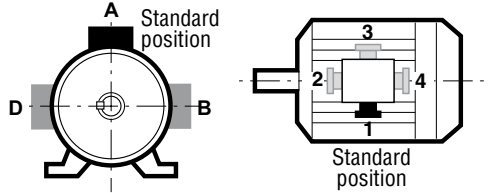

Cable gland position	1	2*	3	4
LSHRM	●	◆	◆	◆
PLSHRM	●	—	▽	▽

* not recommended (impossible on flange mounted motors with smooth hole flanges)

● standard

◆ possible by simply turning round the terminal box

▽ by arrangement (not allowed in certain cases)

CAUTION:

The position of the terminal box cannot easily be changed, even with flanged motors, as the condensation drain holes must be at the bottom.

Using a cable gland (NFC 68 311 and 312 standards)

If the position of the cable gland has not been correctly specified on the order, or is no longer suitable, the symmetrical construction of Dyneo+ motors terminal box allows it to be turned round to different positions. A cable gland must never open upwards.

Check that the incoming cable bend radius prevents water entering via the cable gland.

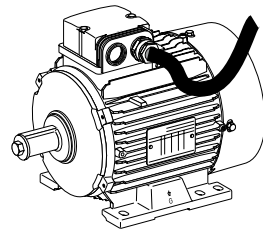
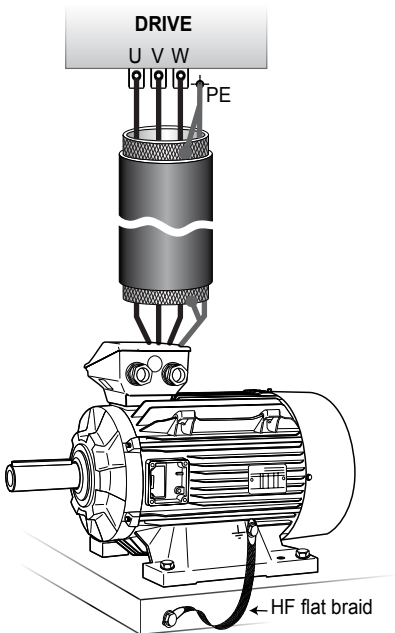

ASSEMBLY AND COMMISSIONING RECOMMENDATIONS

Motors are supplied as standard with terminal boxes pre-drilled and threaded without cable glands or removable undrilled mounting plate depending on the types of motor.

Cable sizes for cable glands
(NFC 68 311 and 312 standards)

Adapt the cable gland and its reducer, if fitted, to the diameter of the cable being used.

In order to maintain the motor's original protection, it is essential to ensure the cable gland provides a total seal by tightening it correctly (so that it cannot be unscrewed by hand).

When there are several cable glands and some are not being used, ensure that they are always closed and tighten them so that they too cannot be unscrewed by hand.

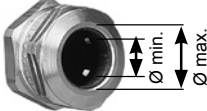

• **Type and cable sizes for cable glands**

Type of cable gland	Cable size	
	Min. cable Ø (mm)	Max. cable Ø (mm)
ISO 16	6	11
ISO 20	8.5	13
ISO 25	13.5	18
ISO 32	17.5	25
ISO 40	24.5	33.5
ISO 50	33	43
ISO 63	42.5	55

To guarantee the protection of the installation in accordance with EMC directive 2014/30/EC, ground continuity (bonding) must be ensured between the cable and the motor ground. A cable gland option, anchored to a armoured cable, is therefore available.

3.5.3 - Motor connections

3.5.3.1 - (F)LSHRM and PLSHRM motors

All motors are supplied with a wiring diagram in the terminal box.

The connector links required for coupling can be found inside the terminal box.

The motors are fitted with a block of 6 terminals complying with standard NFC 51 120, with terminal markings complying with IEC 60034 -8 (or NFC 51 118).

Particular attention must be paid to the information on the nameplate in order to choose the correct type of connection for the supply voltage.

• **400 V Y connection**

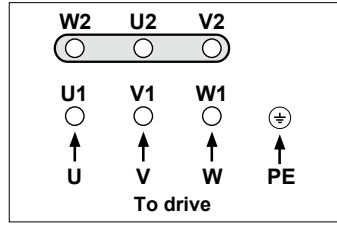

• **400 V Δ connection**

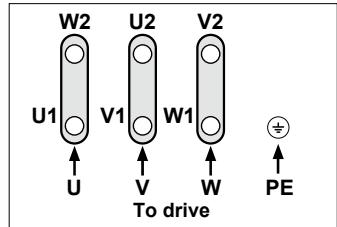

3.5.3.2 - Earth terminal

The earth terminal is located on a connector inside the terminal box; in some cases, the earth terminal can be situated on one of the feet or on one of the cooling fins (round motors). The earth terminal is indicated by the symbol: \perp

The motor housing must be connected to the frame ground via a high-frequency flat braid.

It is compulsory to earth the motor in accordance with current regulations (protection of workers).

3.5.3.3 - Connecting the power supply cables to the terminal block

The cables must be fitted with connectors suitable for the cable cross-section and the terminal diameter.

They must be crimped in accordance with the connector supplier's instructions.

They must be connected with connector resting on connector:

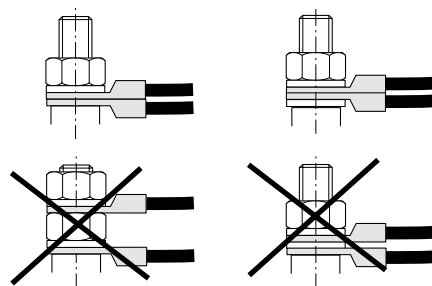

ASSEMBLY AND COMMISSIONING RECOMMENDATIONS

• Tightening torque (N m) for the terminal block nuts

Terminal	M6	M8	M10	M12	M14	M16
Steel	5	10	20	35	50	65

When closing the box, ensure that the seal is correctly positioned.



As a general rule, check that no nut, washer or other foreign body has fallen into the motor housing.

• PLSHRM motor terminal boxes

Holes (smooth holes) are drilled in the multi-level power connection bars, which are supplied without screws or nuts to allow the user to adapt the connection to the connector cross-section.

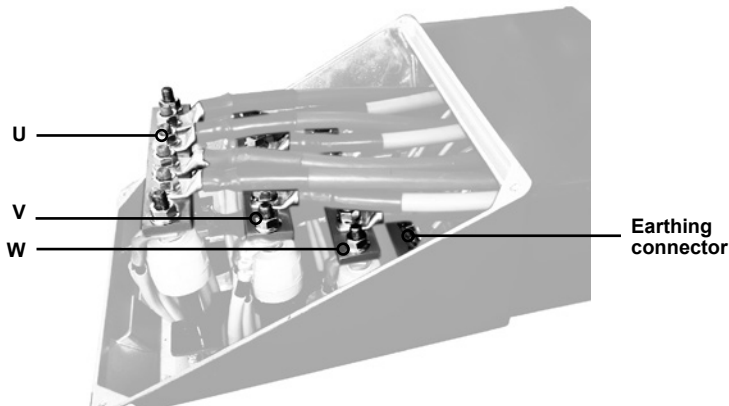
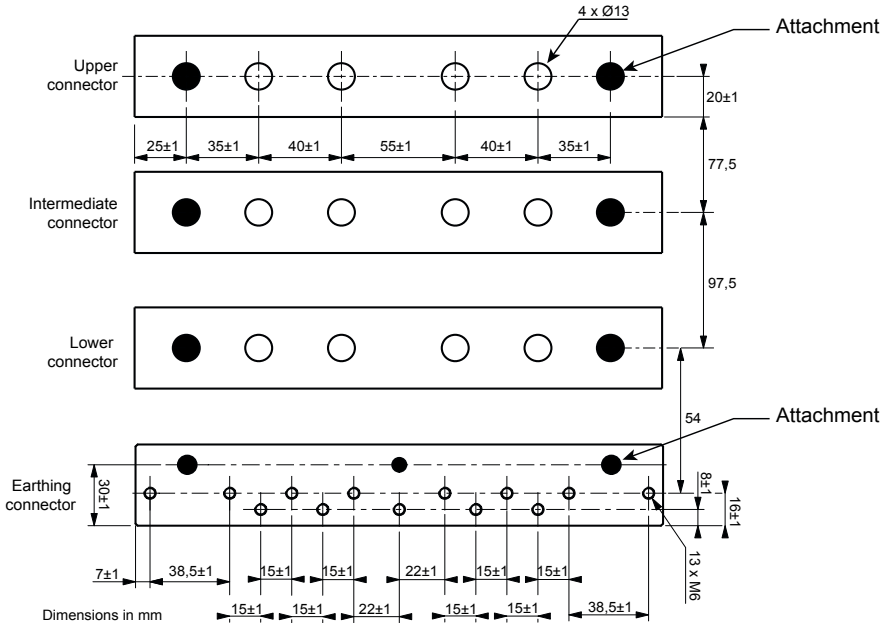

3.5.4 - Power supply cable cross-sections

With equivalent cable cross-sections, the higher the current, the greater the voltage drop in the cables (standard NFC 15.100 or end user's national standard). The voltage drop must therefore be calculated for the motor's current rating indicated on the nameplate and acceptance will depend on the application and the type of cable.

3.5.5 - Forced ventilation option

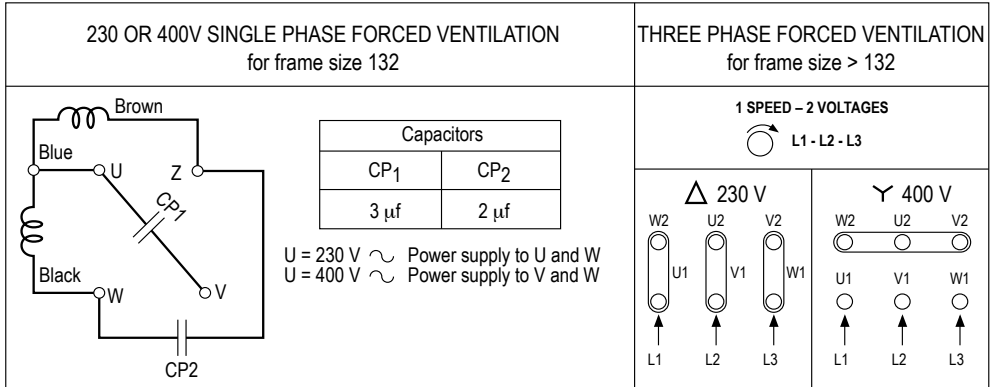

3.5.6 - Connecting protection devices in the terminal box

If the motor is fitted with accessories (thermal protection devices or space heater), they must be connected to strip terminals.

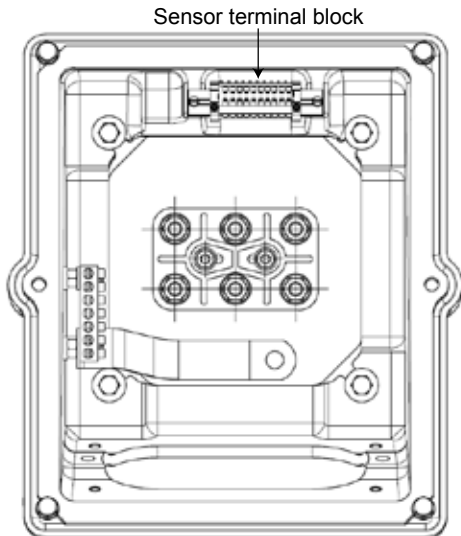

3.5.7 - Connecting PTC sensors to the Powerdrive MD2

Connect the PTC sensors to the DI1/PTC and 0V terminals on the drive control terminal block to ensure that the drive protects the motor from overheating. During commissioning, if the Dyneo+ motor is to be declared as part of the drive [Ctr.02 (11.30) = PMaSR: directed flux control (LSHRM)], the motor's PTC sensor will be automatically covered.

For further information, refer to the drive commissioning manual.



Motor PTC sensors must be connected in order to maintain optimum protection.

NOTE

When the MDX-RESOLVER option is adopted to manage a resolver fitted on the motor, PTC sensors can be connected to this unit, however additional settings will be necessary. Refer to the drive commissioning manual.

3.5.8 - Wiring a resolver

Use a cable with an outer shield that incorporates at least three pairs of twisted and shielded wires (differential signals "excit", "sin", "cos").

Connect the shield at both ends (at 360°): clamp the shield on the drive end and the metallic cable gland on the resolver box.

The shields of the twisted pairs must be connected to 0 V on the drive end as shown in the diagram. Do not connect them at the resolver end.

Reminder: the MDX-RESOLVER option must be selected to allow the Powerdrive MD2 to manage the motor resolver.

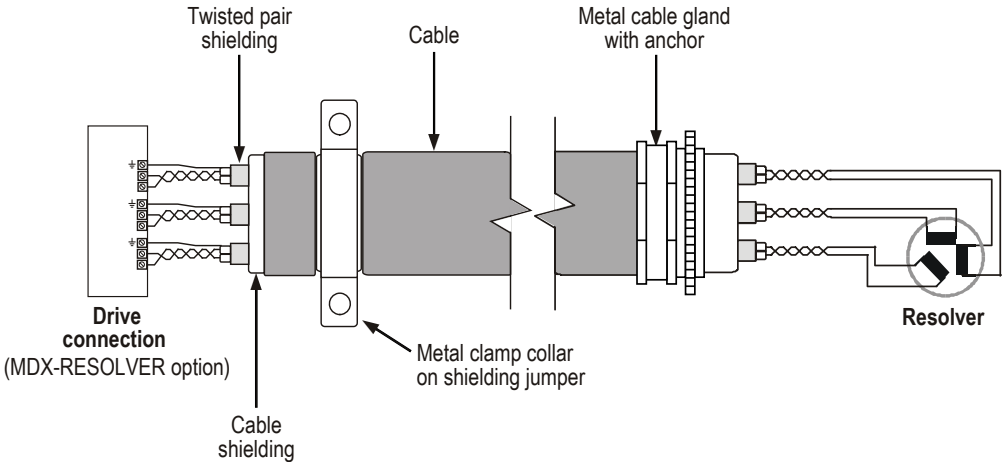

4 - COMMISSIONING THE MOTOR-DRIVE



Prior to commissioning for all motors: run the motor off load (no mechanical load) for 2 to 5 minutes, while checking for abnormal noise. If any abnormal noise arises, see section 7. For motors running at speeds > 3,600 rpm, also see section 5.1.

For information on how to start up the motor and drive package, refer to the manual for the drive used. Quick commissioning is described according to the operating mode chosen (with sensor or sensorless).

5 - ROUTINE MAINTENANCE

5.1 - Checking

• Running-in the bearings for series 4500 and 6000

When the motor is commissioned, and each time the bearings are replaced, the bearings must be run in to obtain optimum service life.

Set the rotation speed to 4,000 rpm, then each time the bearing temperature stabilizes, increase the speed by 500 rpm up to maximum speed. During this period, check that the bearing temperature remains below 110°C.

• Checks during start-up

Check:

- noise,
- vibration,
- button/switch operation,
- also check the current and voltage on the machine while it is operating with the rated load

• Checks after approximately 50 hours' operation.

Check:

- that the screws fixing the motor and the coupling device are correctly tightened,
- if a chain or belt transmission system is fitted, check that the tension is correctly adjusted.

• Annual checks

Check:

- that the screws fixing the motor are correctly tightened,
- electrical connections,
- vibration.

• Cleaning

To ensure the motor operates correctly, remove any dust or foreign bodies which might clog the cover grille and the housing fins.

Necessary precaution: check that the motor is totally sealed (terminal box, drain holes, etc.) before carrying out any cleaning operation.

Dry cleaning (vacuuming or compressed air) is always preferable to wet cleaning.



Always clean at reduced pressure from the centre of the motor towards the extremities to avoid introducing dust and particles under the seals.

• Draining off condensation water

Temperature variations cause condensation to form inside the motor, which must be removed before it adversely affects motor operation.

Condensation drain holes, located at the bottom of the motors (taking account of their operating position) are sealed with plugs which must be removed and then replaced every six months (if they were not replaced, the motor's degree of protection would no longer be maintained).

Clean the orifices and plugs before refitting them.

NOTE

In conditions of high humidity and significant temperature variations, a shorter period is recommended.

The condensation drain plugs can be removed if this has no effect on motor protection levels.

5.2 - Bearings and greasing

5.2.1 - Type of grease

When the bearings are not greased for life, the type of grease is indicated on the nameplate.

Avoid mixing greases.

HA	Speed (rpm)	Lubrication type	Grease
< 225	All	Permanently greased bearings	ENS, WT or BQ 72-72
≥ 225	N ≤ 3600	Bearings with grease nipples	Polyrex EM 103
	N > 3600	Bearings with grease nipples	BQ 72-72

5.2.2 - Permanently greased bearings

Under normal operating conditions, the service life (L10h) of the lubricant is 25,000 hours for a machine installed horizontally and for temperatures less than 40°C.

5.2.3 - Bearings with grease nipples

The bearings are lubricated in the factory.

The end shields are fitted with bearings lubricated by Técalémit grease nipples.

 **The frequency of lubrication and quantity and quality of grease are indicated on the nameplates. Refer to these to ensure correct greasing of the bearings.**

 **The interval between 2 greasing operations must never, under any circumstances, exceed 2 years, even in the event of prolonged storage or downtime.**

5.3 - Bearing maintenance

As soon as you detect any of the following on the motor:

- abnormal noise or vibration,
- abnormal temperature increase for the bearing despite greasing as required, the state of the bearings must be checked.

Damaged bearings must be replaced as soon as possible to prevent worse damage to the motor and the equipment being driven.

If one bearing needs to be replaced, the other bearing must also be replaced, as well as the shaft grounding ring (if fitted on the motor).

Seals should be routinely changed when the bearings are changed.

The free bearing must allow the rotor shaft to expand (check identification during dismantling).

6 - PREVENTIVE MAINTENANCE

Consult LEROY-SOMER, which proposes a preventive maintenance system via its network of service centres.

This system enables data to be obtained on site for the parameters at different points as indicated in the table below.

A computer analysis is then performed using these measurements to produce a report on the behaviour of the installation.

This report highlights problems such as eccentricity, misalignment, the condition of the bearings as well as structural problems, electrical problems, etc.

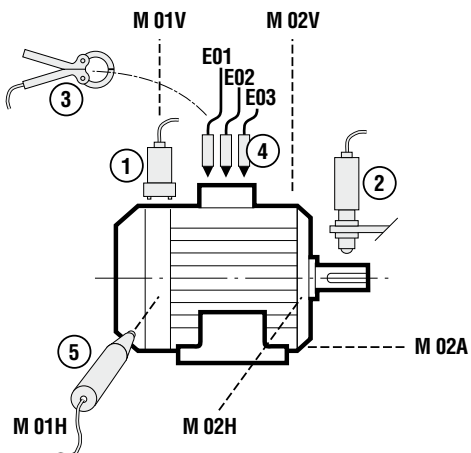

Detector	Measurement	Measurement points								
		M 01V	M 01H	M 02V	M 02H	M 02A	Shaft	E01	E02	E03
1 - Accelerometer	Vibration	•	•	•	•	•				
2 - Photo-electric cell	Speed						•			
3 - Clamp ammeter	Current (DC or 3-phase AC)							•	•	•
4 - Voltage probe	Voltage							•	•	•
5 - Infra-red probe	Temperature	•		•						

TROUBLESHOOTING GUIDE

7 - TROUBLESHOOTING GUIDE

Incident	Possible cause	Remedy
Abnormal noise	Originating in motor or machine being driven?	Uncouple the motor from the equipment being driven and test the motor on its own
Noisy motor	The cause is mechanical if the noise persists after switching off the power supply, with the drive set to "freewheel" mode	
	- vibration	- check that the key is suitable for the type of balancing (see section 3.3)
	- damaged bearings	- change the bearings
	- mechanical friction: ventilation, coupling	- check installation
	The cause is electrical if the noise stops after switching off the power supply	- check the power supply at the motor terminals - check the drive settings
	- normal voltage and 3 phases balanced	- check the connection of the terminal block and the tightening of the connectors
	- abnormal voltage - phase imbalance	- check the power supply at the terminals of the motor and the drive supply - check the winding resistance
Motor heats abnormally	Other possible causes: - incorrect settings - drive malfunction	- refer to the drive manual
	- faulty ventilation	- check the environment - clean the fan cover and the cooling fins - check that the fan is correctly mounted on the shaft
	- unsuitable switching frequency	- comply with the minimum switching frequency indicated on the motor nameplate
	- faulty supply voltage	- check the voltage
	- terminal connection fault	- check that the bars are correctly positioned, as described in section 3.5.3.1.
	- overload	- check the current consumption in relation to that indicated on the motor nameplate
	- partial short-circuit - phase imbalance	- check the electrical continuity of the windings and/or the installation - check the winding resistance
Motor does not start	Other possible causes: - incorrect settings - drive malfunction	- refer to the drive manual
	off load - mechanical obstruction	When disconnected from a power supply: - check that rotation of the shaft is not blocked
	- check that no voltage is present at the motor terminals	- check the voltage at the motor terminals and the drive supply voltage as well as electrical protection devices (e.g. fuses)
	- speed feedback (drive message)	- check wiring, drive settings and the operation of the speed feedback sensor
	- thermal protection	- check the continuity of the PTC sensor
	On load - phase imbalance	When disconnected from a power supply: - check the resistance and continuity of the windings
	- drive - speed feedback (drive message) - thermal protection	- check the settings and sizing (max. current that can be delivered by the drive) - check wiring, drive settings and the operation of the speed feedback sensor - check the continuity of the PTC sensor

Refer to the manual for the drive used for the trips displayed by the drive.

8 - SPARE PARTS

When ordering spare parts, you must indicate the complete motor type, its serial number and the information given on the nameplate (see section 1).

In the case of flange-mounted motors, indicate the type of flange and its dimensions (see below).

IM 3001 (IM B5)

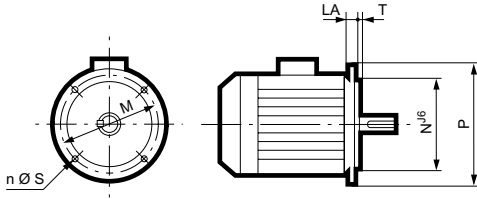

Our extensive network of service centres can dispatch the necessary parts without delay.

To ensure that our motors operate correctly and safely, we recommend the use of original manufacturer spare parts.

In the event of failure to comply with this advice, the manufacturer cannot be held liable for any damage.

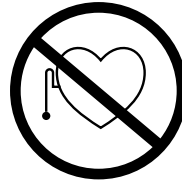

The rotor must not be assembled or maintained by people with pacemakers or any other implanted medical devices.

The motor rotor contains a magnetic field. If the rotor is separated from the motor, its field can affect pacemakers or disturb digital devices such as watches, mobile phones, etc. No magnetized dust must be present in the working environment, which must be kept clean.

Installation, servicing and maintenance must only be carried out by qualified personnel. LEROY-SOMER cannot be held liable for any problems arising from failure to comply with the instructions in this manual.

The product is covered by the warranty during the guarantee period as long as any partial or total dismantling has only been performed with the assistance of LEROY-SOMER (or its approval).

Nidec
All for dreams

LEROY-SOMERTM



Moteurs Leroy-Somer
Headquarters: Boulevard Marcellin Leroy - CS 10015
16915 ANGOULÊME Cedex 9

Limited company with capital of €65,800,512
RCS Angoulême 338 567 258

www.leroy-somer.com